

Mitel MiVoice 6940 IP Phone

58015142 REV01

RELEASE 1.0 USER GUIDE FOR MIVOICE BUSINESS

NOTICE

The information contained in this document is believed to be accurate in all respects but is not warranted by Mitel Networks™ Corporation (MITEL®). The information is subject to change without notice and should not be construed in any way as a commitment by Mitel or any of its affiliates or subsidiaries. Mitel and its affiliates and subsidiaries assume no responsibility for any errors or omissions in this document. Revisions of this document or new editions of it may be issued to incorporate such changes.

No part of this document can be reproduced or transmitted in any form or by any means - electronic or mechanical - for any purpose without written permission from Mitel Networks Corporation.

Trademarks

The trademarks, service marks, logos and graphics (collectively “Trademarks”) appearing on Mitel's Internet sites or in its publications are registered and unregistered trademarks of Mitel Networks Corporation (MNC) or its subsidiaries (collectively “Mitel”) or others. Use of the Trademarks is prohibited without the express consent from Mitel. Please contact our legal department at legal@mitel.com for additional information. For a list of the worldwide Mitel Networks Corporation registered trademarks, please refer to the website: <http://www.mitel.com/trademarks>.

Mitel's Power Over Ethernet (PoE) Powered Device (PD) products are covered by one or more of the U.S. patents (and any foreign patent counterparts thereto) identified at Mitel's website: www.mitel.com/patents.

For more information on the PD patents that are licensed, please refer www.cmspatents.com.

Mitel MiVoice 6940 IP Phone User Guide

58015142 - November 2016

®,™ Trademark of Mitel Networks Corporation
© Copyright 2016, Mitel Networks Corporation
All rights reserved

Software License Agreement

Mitel, hereinafter known as “Seller”, grants to Customer a personal, worldwide, non-transferable, non-sublicenseable and non-exclusive, restricted use license to use Software in object form solely with the Equipment for which the Software was intended. This Product may integrate programs, licensed to Mitel by third party Suppliers, for distribution under the terms of this agreement. These programs are confidential and proprietary, and are protected as such by copyright law as unpublished works and by international treaties to the fullest extent under the applicable law of the jurisdiction of the Customer. In addition, these confidential and proprietary programs are works conforming to the requirements of Section 401 of title 17 of the United States Code. Customer shall not disclose to any third party such confidential and proprietary programs and information and shall not export licensed Software to any country except in accordance with United States Export laws and restrictions.

Customer agrees to not reverse engineer, decompile, disassemble or display Software furnished in object code form. Customer shall not modify, copy, reproduce, distribute, transcribe, translate or reduce to electronic medium or machine readable form or language, derive source code without the express written consent of the Seller and its Suppliers, or disseminate or otherwise disclose the Software to third parties. All Software furnished hereunder (whether or not part of firmware), including all copies thereof, are and shall remain the property of Seller and its Suppliers and are subject to the terms and conditions of this agreement. All rights reserved.

Customer's use of this software shall be deemed to reflect Customer's agreement to abide by the terms and conditions contained herein. Removal or modification of trademarks, copyright notices, logos, etc., or the use of Software on any Equipment other than that for which it is intended, or any other material breach of this Agreement, shall automatically terminate this license. If this Agreement is terminated for breach, Customer shall immediately discontinue use and destroy or return to Seller all licensed software and other confidential or proprietary information of Seller. In no event shall Seller or its suppliers or licensors be liable for any damages whatsoever (including without limitation, damages for loss of business profits, business interruption, loss of business information, other pecuniary loss, or consequential damages) arising out of the use of or inability to use the software, even if Seller has been advised of the possibility of such damages.

- Software License Agreement 1
- Welcome 5
 - About this guide 5
 - Supporting documentation 5
 - Phone features 6
 - Installation and setup 6
 - Cleaning the Mitel MiVoice 6940 IP phone touchscreen 6
 - Tips for your comfort and safety 7
 - Don't cradle the handset 7
 - Protect your hearing 7
 - Adjust the viewing angle 7
- Phone keys 8
 - Key panel 8
 - Key description 9
 - Input methods 10
 - Dialpad keys 10
 - On-screen keyboard 12
- Cordless Bluetooth handset 14
 - Hardware features 15
 - LED indicator 16
 - Alerting tones 16
 - On-screen battery indicator 17
 - Powering on/off the Bluetooth cordless handset 17
- Getting started 18
 - Plugging in and starting the phone 18
 - UI overview 19
 - Navigation 19
 - Home screen 20
 - Call screen 23
- Customizing your phone 24
 - Using the Static Settings menu 25
 - Status 25
 - Language 28
 - Call Forward 29
 - Bluetooth 31
 - Enabling Bluetooth functionality 32
 - Pairing a Bluetooth device 32

Forgetting a Bluetooth device	35
Disconnecting a connected Bluetooth device	36
Renaming a paired Bluetooth device	37
Connecting to a different or disconnected Bluetooth device	39
Audio	40
Ring Tones	40
Audio Path	41
Display	42
Config Teleworker	43
Diagnostics	44
Audio Diagnostics	44
Ping	46
TCP DUMP	47
DHCP Trace	48
Restart	50
Configuring and using programmable keys	51
Speed Call	52
Other Features	52
Phone Lock	52
Call Forward Always	54
Do Not Disturb	56
Account codes	57
Making calls	59
Dialing a number	59
Initiating a callback	59
Redialing a number	59
Receiving calls	60
Answering an incoming call	60
Manually forwarding an incoming call	60
Handling calls	61
Placing a call on hold	61
Muting the microphone	61
Transferring a call	62
Creating a multi-party conference call	63
Ending a conference and transferring remaining parties	65
Ending calls	65
Managing calls	66

Contacts	66
General functions	67
Personal folder features	71
Corporate and Mobile folder features	76
Call History	80
Deleting entries from the Call History application	82
Copying entries to the Personal folder in the Contacts application	85
Missed calls indicator	86
Voicemail	87
MobileLink	88
Pairing a mobile phone using Bluetooth	89
Syncing mobile contacts	89
Answering an incoming mobile call using your Mitel MiVoice 6940 IP phone	90
Moving audio from an active mobile call between your mobile phone and Mitel MiVoice 6940 IP phone	91
Additional features	92
Accessory support	97
Mitel M695 Programmable Key Module (PKM)	97
Mitel Wireless LAN Adapter	98
Mitel cordless Bluetooth handset	98
Hardware features	100
LED indicator	100
On-screen battery indicator	101
Alerting tones	102
Powering on/off the Bluetooth cordless handset	102
Analog, DHSG/EHS, and USB headsets	102
Limited warranty	104
Exclusions	104
Warranty repair services	104
After warranty service	104

Welcome

The Mitel MiVoice 6940 IP phone is a top-of-the-line executive phone with a large high-resolution touch display that delivers graphically rich applications. As a full-feature enterprise-class phone, the Mitel MiVoice 6940 IP phone provides 96 programmable self-labeling keys and six intuitive state sensitive softkeys.

The Mitel MiVoice 6940 IP phone features superior sound quality with a cordless Bluetooth handset featuring enhanced audio capabilities, a speakerphone that utilizes advanced audio processing to achieve richer and clearer handsfree conversations, and native Bluetooth and USB headset functionality.

The 6940 IP phone supports MobileLink, a feature that provides seamless mobile integration using Bluetooth wireless technology. MobileLink highlights include the ability to:

- Answer a mobile phone call using your Mitel MiVoice 6940 IP phone.
- Effortlessly move mobile call audio between the Mitel MiVoice 6940 IP phone and your mobile phone.
- Sync your mobile phone's contact list with your Mitel MiVoice 6940 IP phone.

Accommodating today's high speed networks through dual Gigabit Ethernet ports, the Mitel MiVoice 6940 IP phone also offers plenty of support for Mitel and third-party peripherals and has an environmentally efficient PoE class 3 rating. The Mitel MiVoice 6940 IP phone is one of the most advanced desktop IP phones available on the market today and is ideal for any enterprise executive or manager, Teleworker, and Contact Center employee.

The 6940 IP phone is compatible with the MiVoice Business phone system.

About this guide

This guide explains how to use the basic features of your new Mitel MiVoice 6940 IP phone. Not all features listed are available by default. Your System Administrator has the ability to customize many features on this phone. Contact your System Administrator to find out which features and services are available to you on your phone system.

Supporting documentation

To access phone and system-specific documentation:

1. In your browser, go to <http://www.mitel.com>.
2. Click **Product Manuals** under the **Support** section.
3. Select **PDF Guides and Online Help** under the **End User Documents** drop-down menu.
4. In the left-hand menu, navigate to **Telephones**.

Phone features

Feature highlights include:

- 7" WVGA (800x480) color TFT capacitive touch-screen LCD display with brightness controls
- Built-in-two-port, 10/100/1000 Gigabit Ethernet switch
- Embedded Bluetooth 4.0
- USB 2.0 port (500mA maximum)
- Cordless Bluetooth handset
- Enhanced wideband, full-duplex speakerphone for handsfree calls
- Extensive support for peripherals and modules: USB and Bluetooth headsets, M695 Color Programmable Key (PKM) modules, and Mitel Wireless LAN Adapter
- AC power adapter (sold separately)
- 96 programmable, multi-function, self-labeling keys and six intuitive state sensitive softkeys
- MobileLink support - seamless mobile integration using Bluetooth wireless technology

Installation and setup

Please refer to the *Mitel MiVoice 6940 IP Phone Installation Guide* included with your phone for basic installation and physical setup information.

Cleaning the Mitel MiVoice 6940 IP phone touchscreen

Repeated use of the Mitel MiVoice 6940 IP phone may lead to a dirty screen. To clean the phone's screen, Mitel recommends the use of a super fine cotton cloth, cotton swab, or microfiber lens cloth made of microfiber suede (preferably one without sewn hems or similar characteristics that would scratch the surface of the screen). You can use the cloth dry for dusting, polishing and light cleaning, or dampen it (with water only) to deep clean the surface. If using a damp cloth, make sure to use just a little water on the cloth. Too much moisture can cause damage to your phone that could be permanent. If the cloth is dripping or the surface shows water spots after wiping, then you are using too much water on the cloth.

Some rules to follow when cleaning your screen include:

- Do not use any sharp objects including your fingernail.
- Do not rub, touch or tap the surface of the screen with sharp or abrasive items such as a ball-point pen or a screw driver.
- Do not use any type of cleansers including abrasive cleansers.
- Do not use any type of glass cleaner or any cleaner that contains alcohol or ammonia.
- Do not spray any type of cleaner directly on the phone's screen.

- Do not allow any liquid to run down the surface of the touchscreen and under the bezel.
- If using a damp cloth, disconnect power to the phone before wiping the screen.

CAUTION: Use of any type of cleaners, alcohol, ammonia, and/or hard or sharp objects can harm the touchscreen surface and potentially cause transparent conductive film cracks in the screen.

To clean your Mitel MiVoice 6940 IP phone's touchscreen:

1. Disconnect power to your phone.
2. Retrieve a soft cloth, such as a microfiber cloth.
3. If necessary, dampen the cloth. For regular cleanings, a dry cloth is usually sufficient. For stubborn build-up or for periodic deep cleanings, wet the cloth under a faucet and then wring out until it is just damp.
4. Wipe the screen gently with the cloth making sure to not get any moisture in the sides of the screen. You can also wipe down the entire phone to remove dirt and grime.
5. Allow your phone to completely dry after you are done cleaning. This should only take a few minutes.
6. Reconnect power to your phone.

Note: Keeping your touchscreen clean and free of dirt and fingerprints on a regular basis extends the life of your phone's touchscreen.

Tips for your comfort and safety

Don't cradle the handset

Prolonged use of the handset can lead to neck, shoulder, or back discomfort, especially if you cradle the handset between your ear and shoulder. If you use your phone a lot, you may find it more comfortable to use a headset. See "[Accessory support](#)" on [page 97](#) for more information on headsets.

Protect your hearing

Your Mitel MiVoice 6940 IP phone has a control for adjusting the volume of the handset, headset, and speakerphone. Because continuous exposure to loud sounds can contribute to hearing loss, keep the volume at a moderate level.

Adjust the viewing angle

The stand for your Mitel MiVoice 6940 IP phone supports two viewing angles (30° and 60°). Adjust the stand to suit your viewing preference. For instructions on how to adjust the stand, see the *Mitel MiVoice 6940 IP Phone Installation Guide*.

Phone keys

Key panel



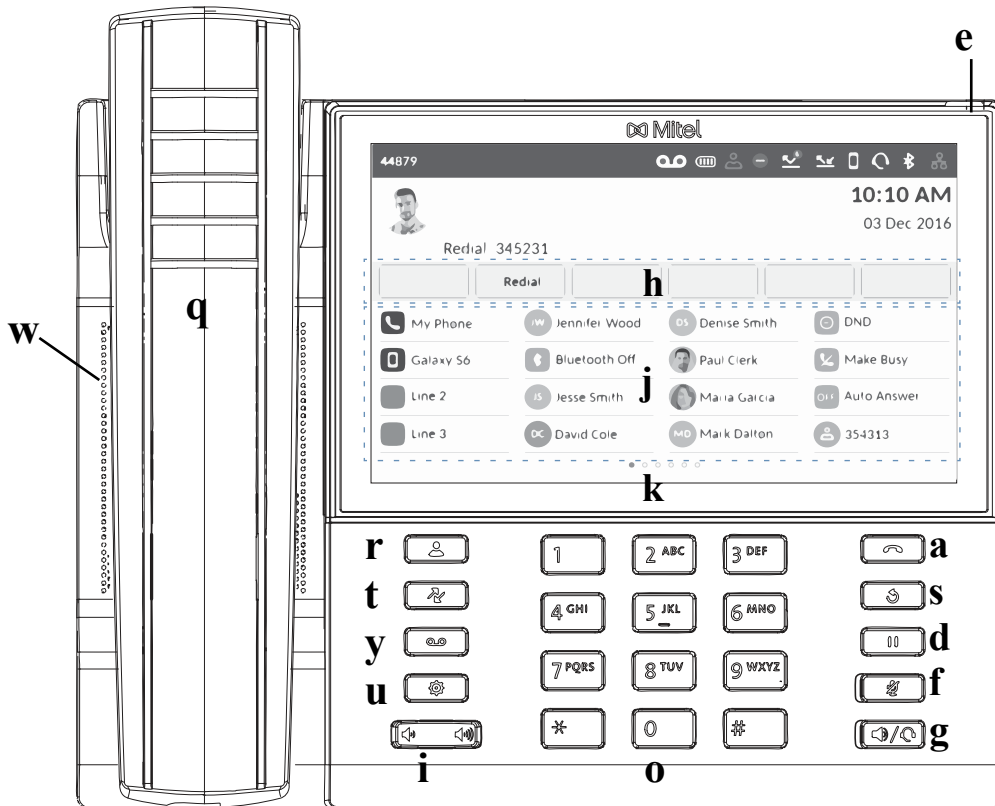







The following sections describe the various Mitel MiVoice 6940 IP phone key functions and how they can help you make and manage your calls and caller information.

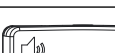

q	Bluetooth Cordless Handset	a	Goodbye Key
w	Speaker	s	Redial Key
e	Message Waiting Indicator (MWI)	d	Hold Key
r	Contacts Key	f	Mute Key
t	Call History Key	g	Speaker/Headset Key
y	Voicemail Key	h	State-Sensitive Softkeys
u	Settings Key	j	Programmable Keys
i	Volume Control	k	LCD Touchscreen
o	Dialpad		

Key description

The following table describes the keys on the Mitel MiVoice 6940 IP phone:

Key	Description
	Contacts key - Displays a list of your contacts. For more information, see “ Contacts ” on page 66 .
	Call History key - Displays a list of your missed, outgoing, and answered calls. For more information, see “ Call History ” on page 80 .
	Voicemail key - Provides access to your voicemail service (if configured). For more information, see “ Voicemail ” on page 87 .
	Settings key - Provides services and static settings that allow you to customize your phone. For more information, see “ Customizing your phone ” on page 24 .
	Volume controls - Adjusts the volume for the ringer, handset, headset, and speakerphone. Press the volume control keys while the phone is ringing to adjust the ringer volume. Pressing these keys during an active call adjusts the volume of the audio device being used (handset, headset, or speaker).
	Goodbye key - Ends an active call. The Goodbye key also exits an open list (such as Call History) and menus (such as the Static Settings menu) without saving changes.
	Redial key - Displays a list of your previously dialed calls. Pressing the Redial key twice redials the last dialed number displayed on the Home screen. For more information, see “ Redialing a number ” on page 59 .
	Hold key - Places an active call on hold. To retrieve a held call, tap the applicable Line key. For more information, see “ Placing a call on hold ” on page 61 .
	Mute key - Mutes the microphone so that your caller cannot hear you (the LED beside the key turns on when the microphone is on mute). For more information, see “ Muting the microphone ” on page 61 .
	Speaker/Headset key - Transfers the active call to the speaker or headset, allowing handsfree use of the phone. For more information, see “ Audio Path ” on page 41 .

Input methods

Dialpad keys

The Mitel MiVoice 6940 IP phone has a dialpad with digits from 0 through 9, a * key, and a # key. Keys 2 through 9 contain the letters of the alphabet. These dialpad keys can be used to dial a phone number to make a call (see “[Making calls](#)” on [page 59](#)) and to press keys requested by an Interactive Voice Response (IVR) system. The basic inputs for the Mitel MiVoice 6940 IP phone dialpad includes the following:

Dialpad Key	Description
0	Dials 0
1	Dials 1
2 ABC	Dials 2 When entering text, this key enters A with one press, B with two presses, and C with three presses.
3 DEF	Dials 3 When entering text, this key enters D with one press, E with two presses, and F with three presses.
4 GHI	Dials 4 When entering text, this key enters G with one press, H with two presses, and I with three presses.
5 JKL	Dials 5 When entering text, this key enters J with one press, K with two presses, and L with three presses.
6 MNO	Dials 6 When entering text, this key enters M with one press, N with two presses, and O with three presses.
7 PQRS	Dials 7 When entering text, this key enters P with one press, Q with two presses, R with three presses, and S with four presses.
8 TUV	Dials 8 When entering text, this key enters T with one press, U with two presses, and V with three presses.
9 WXYZ	Dials 9 When entering text, this key enters W with one press, X with two presses, Y with three presses, and Z with four presses.

The * is called the star key. The # is called the pound key, number sign, or hash key, depending on one's nationality or personal preference. These can be used for special functions such as accessing advanced services. The star key and pound key functions are dependent on your call server's feature availability. Contact your System Administrator for more information about available functions using these keys.

When entering characters in the various **Static Settings** menus or in different applications (for example, when adding a contact to your **Contacts** application), advanced characters can be entered using the dialpad keys.

The following tables identifies the characters that you can use and the order in which they are accessible.

Key	Uppercase Characters	Lowercase Characters
0	0 +	0 +
1	1 . : ; = _ , - ' & () \$!	1 . : ; = _ , - ' & () \$!
2	A B C 2	a b c 2
3	D E F 3	d e f 3
4	G H I 4	g h i 4
5	J K L 5	j k l 5
6	M N O 6	m n o 6
7	P Q R S 7	p q r s 7
8	T U V 8	t u v 8
9	W X Y Z 9	w x y z 9
*	* <SPACE>	* <SPACE>
#	# / \ @	# / \ @

On-screen keyboard

In addition to the Mitel MiVoice 6940 IP phone's dialpad keys, an on-screen international keyboard is available for character input. The on-screen international keyboard automatically displays in various applications when character input is required.

The lower case layout of the on-screen international keyboard is as follows:



The upper case layout of the on-screen international keyboard is as follows:

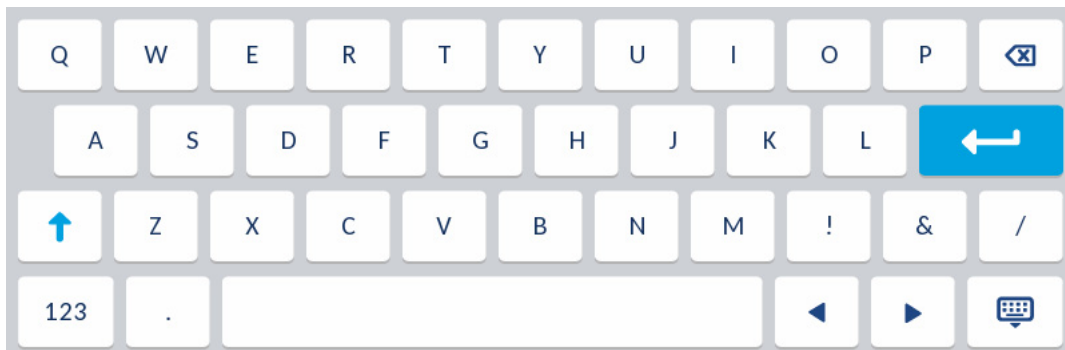

The numeric layout of the on-screen international keyboard is as follows:



Pressing and holding various keys on the on-screen keyboard allows you choose diacritical and secondary characters. The diacritical and secondary characters available for the on-screen international keyboard include:

Press and hold	Available diacritics/secondary characters						
e	è	é	ê	ë	ē	ě	é
u	ù	ú	û	ü			
i	ì	í	î	ï	ī	ı	
o	ò	ó	ô	õ	ö	œ	ø
a	à	á	â	ã	ä	â	æ ā
c	ç	ć	č				
l	ł						
n	ñ	ń					
y	ÿ						
s	ß						
!	ı						
?	¿						
\$	€	£					
({	[<				
)	}]	>				
`	~						
=	+						
/		\					
-	_						

Cordless Bluetooth handset

Included with your Mitel MiVoice 6940 IP phone is a cordless Bluetooth handset. With a potential range of up to 10 meters (30 feet), the Bluetooth handset offers convenience and corridor mobility for Mitel MiVoice 6940 IP phone users.

Feature highlights include:

- Hookswitch (Initiate call/end call) key
- Volume control keys
- Mute key
- Built-in handset ringer
- LED indicators to indicate both connectivity and charging status
- At least six hours talk time
- Over 40 hours standby time
- Handset battery recharge time of three hours or less
- Operating range of up to 30 feet (10 meters) from the IP phone
- Wideband audio capable

Note: The handset comes automatically paired with your Mitel MiVoice 6940 IP phone so it should be ready to use immediately. If at any point you need to pair the handset with your phone again, power on the handset by placing the handset on the IP phone's cradle and follow the procedures detailed in ["Pairing a Bluetooth device"](#) on page 32.

Hardware features

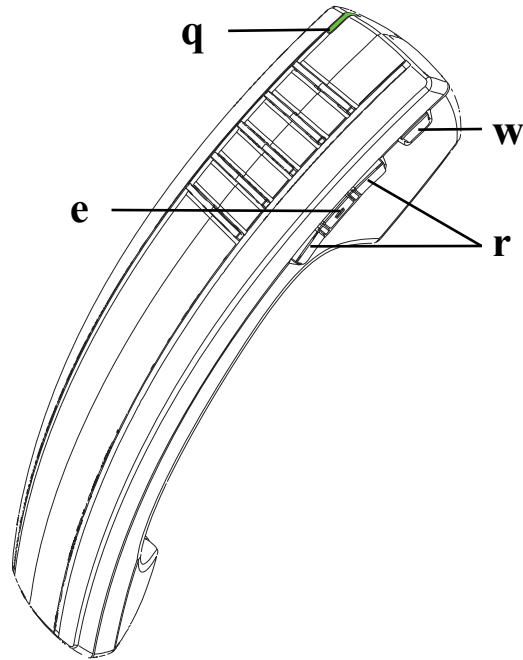

Number	Feature	Description
q	LED	Blue - Indicates the status of the handset. Green - Indicates the status of the handset battery. For more information, see “LED indicator” on page 16 .
w	Hookswitch key	Lifting the handset from the cradle activates the handset. If the handset is already out of the cradle, pressing the Hookswitch key is equivalent to taking the handset off hook. Pressing the key again is equivalent to placing the handset on hook. Pressing the Hookswitch key while on a speakerphone call moves the call to the cordless handset.
e	Mute key	Mutes the handset microphone so that your caller cannot hear you. For more information, see “Muting the microphone” on page 61 .
r	Volume controls	Adjusts the volume for the handset. Press the key above the Mute key to increase the volume and press the key below the mute key to decrease the volume.

LED indicator

The cordless Bluetooth handset has two LEDs:

- Blue – indicates the operational status of the handset.
- Green – indicates the status of the electrical charge of the battery.

LED color, states, and indicator descriptions are as follows:

LED Color	LED State	Indicates
Blue (Handset Not in Cradle)	Blinking	Handset is not connected and is in pairing mode.
	Winking	Handset is connected but not in use.
	Fading	Handset is connected and in use.
Green (Handset in Cradle)	Solid	Battery is fully charged.
	Winking	Battery is charging. Note: It is normal for the handset LED to cycle between winking and solid as battery charge is maintained.
	Off	When handset is cradled and the LED does not flash or illuminate, this indicates an absence of battery power. During the first 30 – 60 minutes that the light is off, the battery may be trickle charging. If that is the case, the LED will resume normal behavior within that 60 minute period. If the LED remains off for more than 60 minutes, then either the battery is no longer chargeable or there is a problem in the charging circuit.

Notes:

1. Blinking denotes the LED is alternating very quickly between on and off.
2. Winking denotes the LED is alternating between being on for a short period of time and then off for a longer period of time.
3. Fading denotes the LED is alternating between fading in and out.

Alerting tones

The handset provides the following alerting tones:

Event	Tone
Power OFF	Four tones successively decreasing in pitch.
Mute key on handset ON	Two low pitched tones

On-screen battery indicator

The battery level is also indicated on-screen in the status bar.

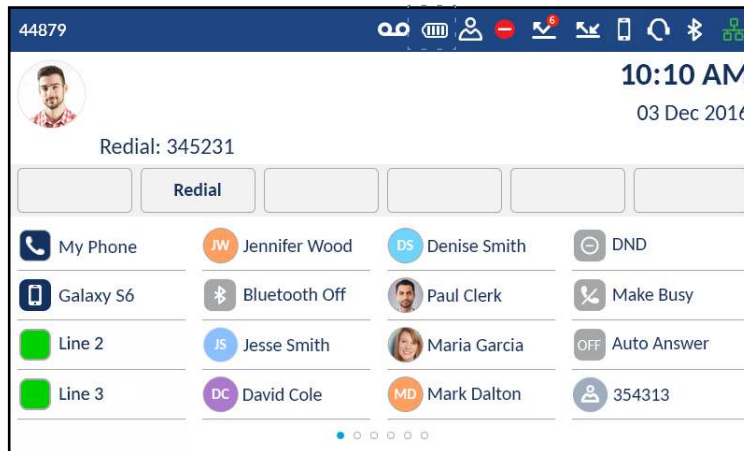

Icons and descriptions are as follows:

Icon	Description
	Battery is fully charged.
	Battery is two-thirds charged.
	Battery is one-third charged.
	Warning - low battery (within 20 minutes of battery life left).
	Critical warning - low battery (within 2 minutes of battery life left). Note: To continue with a call when the battery of the handset reaches this level, switch to speakerphone or headset mode and then charge the handset by placing the handset on the cradle.

Powering on/ff the Bluetooth cordless handset

To power on the Bluetooth cordless handset place the handset on the IP phone's cradle.

To power off the Bluetooth cordless handset, press the **Hookswitch** key for approximately six seconds until the LED indicator turns blue and then turns completely off.

Getting started

The Mitel MiVoice 6940 IP phone must be set up and be configured prior to its first use. This section describes phone behavior and start up screens you may see when the phone is first plugged in, or when it is restarted.

Plugging in and starting the phone

The Mitel MiVoice 6940 IP phone automatically begins the start up and network discovery sequence as soon as it is connected. The phone goes through this process the first time you plug in your phone and every time you restart your phone.

The phone displays the following startup screens:



The Mitel MiVoice 6940 IP phone then contacts the call server and completes the start up process.



WARNING: DO NOT UNPLUG OR REMOVE POWER TO THE PHONE DURING THE START UP PROCESS.

UI overview

Navigation

UI navigation is performed using the LCD touchscreen:

- Press and hold a programmable key to configure the programmable key (see “[Configuring and using programmable keys](#)” on [page 51](#) for more information).
- Swipe left and right in the programmable key area to switch programmable key pages.
- Swipe up and down in the various settings menus as well as the **Contacts** and **Call History** applications to scroll through the respective list of values, contacts, and entries.
- Tap an item on screen to select the item or perform an action.

Home screen

When the phone has successfully booted up and connected to the network, the phone displays the **Home** screen. The **Home** screen shows the date and time along with your number and last dialed number. It is the default screen displayed when the phone is in an idle state.

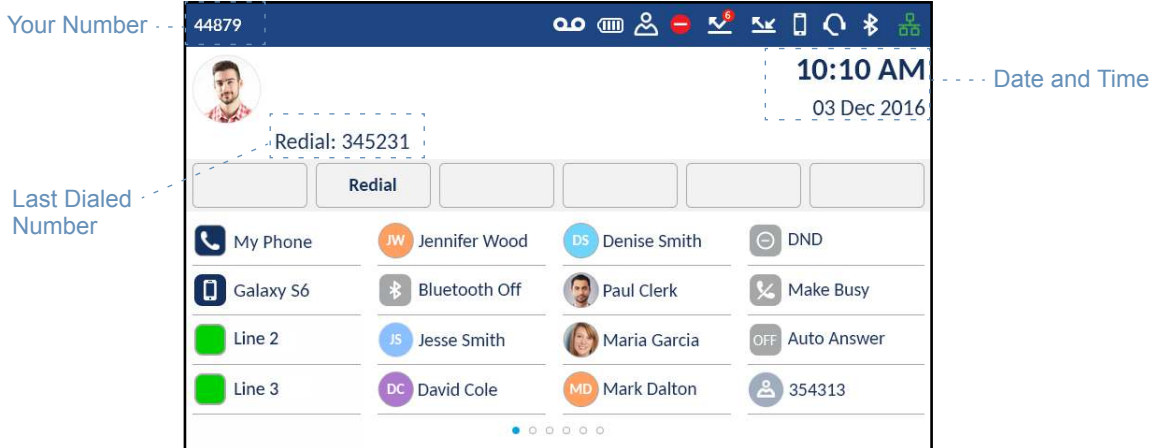

Notes:







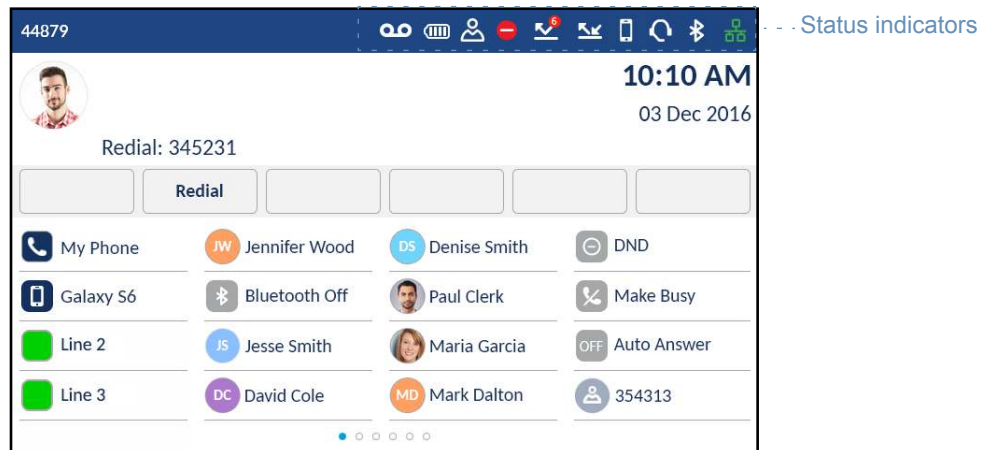







1. Your System Administrator should have configured your number and any other administrative features required. If your number does not display on the screen, contact your System Administrator.
2. Avatars are only available if set up by your System Administrator. If avatars are not available, contact's initials (if available) or a generic avatar is displayed.

Phone and network status indicators

There are icons that display on the phone to indicate the status of the phone and network. These icons display on the upper right corner of the **Home** screen.



The following table identifies and describes the phone and network status indicators on the **Home** screen.

Icon	Description
	Network Connected - The Network Connected icon displays on the Home screen when the phone is connected to the MiVoice Business call server.
	Attempting Network Connection - The Attempting Network Connection icon displays on the Home screen when the phone is attempting to connect to the MiVoice Business call server.
	Network Disconnected - The Network Disconnected icon displays on the Home screen when the phone loses connection to the MiVoice Business call server. If this icon is displayed and you are using an AC adapter for power, check that the Ethernet cable is tightly connected to the phone and to the network device port. The phone should automatically detect when it is reconnected and attempt to connect to the network. If this does not resolve the issue, check with your System or Network Administrator for assistance.
	Bluetooth Enabled - The Bluetooth Enabled icon displays on the Home screen when Bluetooth functionality has been turned on. For more information on Bluetooth functionality, see "Bluetooth" on page 31.
	Headset Connected - The Headset Connected icon displays on the Home screen when a Bluetooth or USB headset connection has been detected. For more information on headset functionality, see "Bluetooth" on page 31 and "Mitel cordless Bluetooth handset" on page 98.
	Mobile Phone Connected - The Mobile Phone Connected icon displays on the Home screen when a mobile phone connection has been detected. For more information on mobile integration features, see "MobileLink" on page 88.
	Call Forward Always - The Call Forward Always icon displays on the Home screen when the Call Forward feature is enabled using the "Always" condition (as opposed to the "Busy" and "No Answer" conditions). For more information on the Call Forward feature, see "Call Forward" on page 29.
	Missed Calls - The Missed Calls icon displays on the Home screen only when incoming calls have not been received. The number in the red badge indicates how many calls were missed. To access a list of your missed calls, press the  (Call History) key. For more information on missed calls, see "Missed calls indicator" on page 86.
	Do Not Disturb - The Do Not Disturb (DND) icon displays on the Home screen when the DND feature is enabled. When DND is enabled, callers calling into the phone hear a DND signal and a "Do Not Disturb" message is displayed on their phones. For more information on the DND feature, see "Do Not Disturb" on page 56.
	Hotdesk User - The Hotdesk User icon displays on the Home screen when you log in using your hotdesk account.
	Handset Battery - The Handset Battery icon displays on the Home screen indicating how much battery life is left for the handset. For more information on the cordless Bluetooth handset, see "Cordless Bluetooth handset" on page 14.
	Voicemail - The Voicemail icon displays on the Home screen only if you have new messages waiting. To access your voicemail messages, press the  (Voicemail) key. For more information on voicemail functionality, see "Voicemail" on page 87.

Programmable keys, state-sensitive softkeys, and the prime line key

16 programmable keys (including the **Prime Line** key) and five state-sensitive softkeys are always displayed on the **Home** screen. The programmable keys allow you to configure up to 96 different features (such as speed calls, phone lock, DND, and so on).

Note: If enabled by your System Administrator, certain features can be programmed on the programmable keys by pressing and holding the respective programmable key. Others can only be programmed by your System Administrator through the MiVoice Business call server. See “[Configuring and using programmable keys](#)” on [page 51](#) for information on how to program the programmable keys using the phone. Contact your System Administrator for details on what features are available to be programmed through the MiVoice Business call server.

The state-sensitive softkeys change depending on the state of the phone and are used to perform different functions when the phone is in an idle, connected, outgoing, or busy state.

The **Prime Line** key is a visual indication of the status of your prime line. When your phone is in an idle state, your  (**Prime Line**) icon is solid blue. Your System Administrator may also have configured additional line appearances on your phone. Line appearance keys are solid green when your phone is in an idle state.

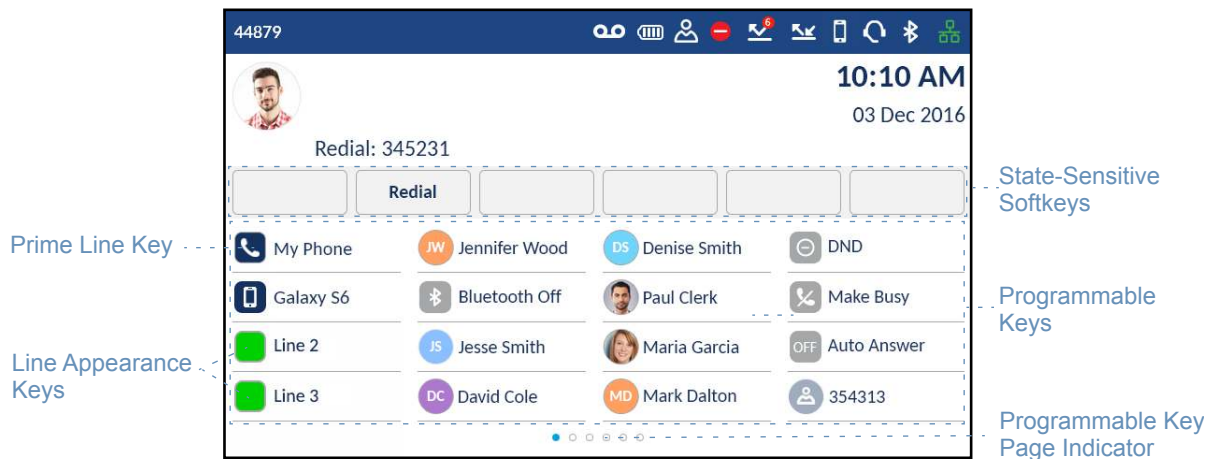

If you have 16 or more programmable keys configured, programmable page indicators are displayed at the bottom of the screen. These dots indicate the number of programmable key pages and its relative position. Swipe left and right on the programmable key area to switch the programmable key pages.

Call screen

During an incoming or outgoing call and when on an active call, all the essential information regarding the call is displayed on screen, including the caller's avatar, name, number, and call duration timer. The context-sensitive softkeys also change allowing you access to more call handling features (such as **Transfer** and **Add User** during an active call).

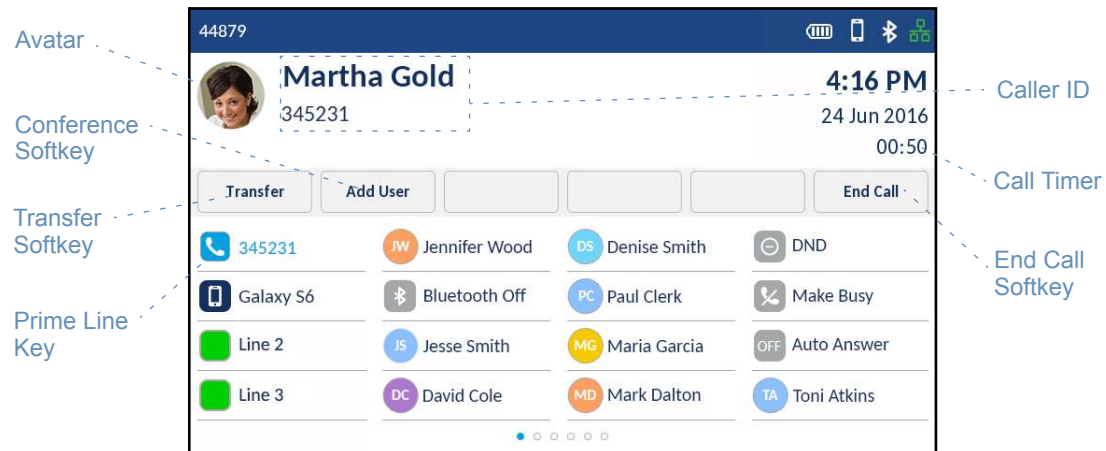

Additionally, if the call is on the **Prime Line** key, the **Prime Line** key changes to reflect the status of the line as per the following table.

Icon	Description
	(Blinking) Indicates the prime line is ringing due to an incoming call.
	Indicates the prime line is busy.
	(Blinking) Indicates the call on the prime line is on hold.

If the call is on a different line, the applicable line appearance key change to reflect the status of the line as per the following table.

Icon	Description
	(Blinking) Indicates the applicable line is ringing due to an incoming call.
	Indicates the applicable line is busy.
	(Blinking) Indicates the call on the applicable line is on hold.

Customizing your phone

You can customize your phone and view your phone status by pressing the  (**Settings**) key, opening the **Static Settings** menu. This menu provides a single location to access all your phone settings. The following phone settings can be configured through the **Static Settings** menu:

Icon	Option
	Status
	Language
	Call Forward
	Config Teleworker
	Diagnostics
	• Audio Diagnostics
	• Ping
	• TCP DUMP
	• DHCP Trace
	Bluetooth (6930 and 6940 only)
	Audio
	• Ring Tones
	• Audio Feedback
	• Audio Path
	Display
	Restart

Notes:

1. The **Advanced** options are Administrator-level functions only, and are not accessible by the user. These options should only be set up and changed by your System Administrator.
2. The **Log Issue** softkey is used to generate a log file that can help Administrators debug issues. You should only tap this softkey when requested by your System Administrator.

Using the Static Settings menu

1. Press the  (**Settings**) key on the phone to enter the **Static Settings** menu.

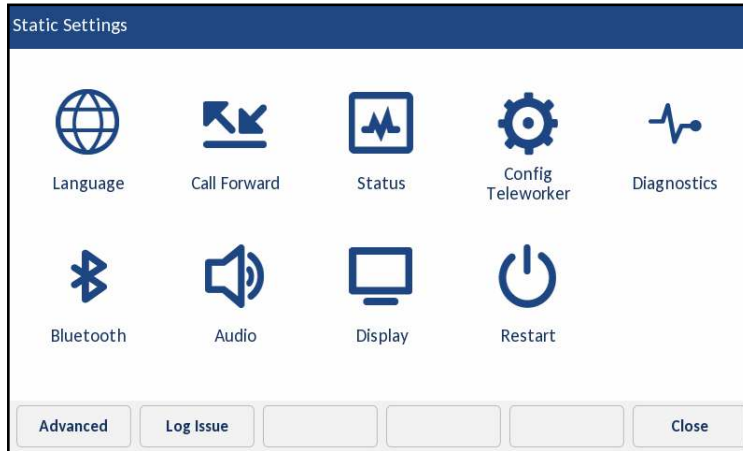

2. Tap the applicable icon to enter the respective settings menu.
3. Swipe up and down to scroll through available lists and tap an on-screen item to select the item.
4. Use the dialpad keys or the on-screen keyboard to enter characters.
5. Tap the **Save** softkey to save your changes.
6. Press the  (**Goodbye**) key or tap the **Close** softkey at any time to exit without saving changes.

Note: For more information about **Advanced** options, contact your System Administrator.

Status

The **Status** settings in the **Static Settings** menu allows you to view your phone's:

- **Network General Info:**
General information regarding your phone's network settings such as IP address, subnet mask, gateway, MAC address, call server IP addresses, TFTP server IP address and port, IPA IP address, and DNS values.
- **Network Persistent Data:**
The IP addresses for call servers 1 to 4.
- **Network DHCP Info:**
Information regarding your phone's Dynamic Host Configuration Protocol (DHCP) status and T1/T2 renewal times.
- **Network Status QoS:**
Information regarding Quality of Service (QoS) features such as Virtual LAN (VLAN), Layer 2 Tunneling Protocol (L2P), and Differentiated Services Code Point (DSCP).
- **Port Info:**
Speed and duplex values for both the LAN and PC ports.

- **Phone Info:**
General phone-related information such as model number, hardware and call server revisions, main firmware version, and boot version.

Note: Tap the **Copyright** softkey to view copyright information.

To view the **Status** menu:

1. Press the  (**Settings**) key on the phone to enter the **Static Settings** menu.
2. Tap the **Status** icon.
3. Tap the status category to view the status details and swipe up and down to scroll through any available lists.

The following status items are available to view:

- Network General Info

Status	
Network General Info	IP Address 10.72.32.69
Network Persist. Data	Subnet Mask 255.255.255.0
Network DHCP Info	Gateway 10.72.32.1
Network Static QoS	MAC Address 08-00-0F-9F-96-68
Port Info	Current Call Server IP Addr... 10.35.96.90
Phone Info	Call Server1 IP Address 10.35.96.90
	Call Server2 IP Address
Cancel	

- Network Persistent Data

Status	
Network General Info	Call Server1 IP Address
Network Persist. Data	Call Server2 IP Address
Network DHCP Info	Call Server3 IP Address
Network Static QoS	Call Server4 IP Address
Port Info	
Phone Info	
Cancel	

- Phone Info

Status	
Network General Info	Model MINET_6940
Network Persist. Data	Hardware Rev. NOT AVAILABLE YET
Network DHCP Info	Call Server Rev. 14.0.0.69
Network Static QoS	Main Version 01.00.00.125
Port Info	Boot Version
Phone Info	
Copyright	
	Cancel

Language

The Mitel MiVoice 6940 IP phone supports the following languages:

- English
- French
- German
- Spanish
- Spanish (Latin America)
- Portuguese
- Portuguese (Brazil)
- Dutch
- Italian
- Romanian
- Russian
- Swedish
- Polish

When you set the language on the phone, all on-screen text (in idle/call screens, static setting menus, and applications) displays in the selected language.

Notes:

1. All languages may not be available for selection as availability is dependent on the language files provided by the MiVoice Business call server. Contact your System Administrator for details on what languages are available in your specific environment.
2. Unofficially supported languages may be available for selection on your phone depending on the language files available on the MiVoice Business call server. If available, these languages can be used by selecting Local 1 or Local 2 in the **Language** menu.

To specify the language in which on screen text displays:

1. Press the  (**Settings**) key on the phone to enter the **Static Settings** menu.
2. Tap the **Language** icon.

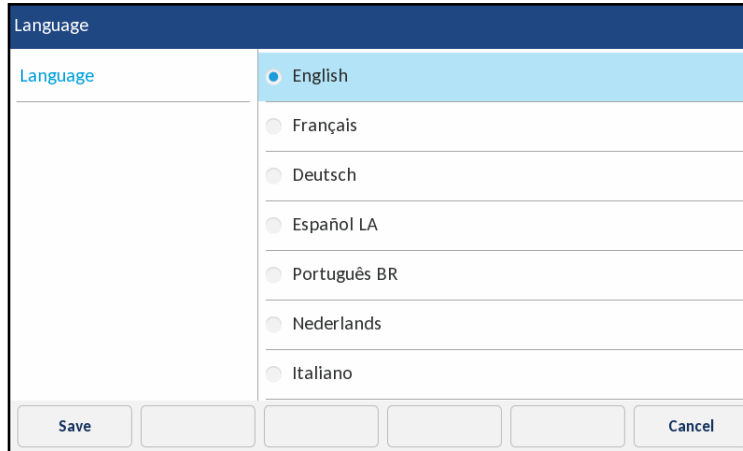

3. Swipe up and down to view the language available for selection.
4. Tap the applicable language.
5. Tap the **Save** softkey to save your changes.

Call Forward

Call Forward on the Mitel MiVoice 6940 IP phone allows incoming calls to be forwarded to another destination. You can enable your calls to be forwarded:

- When your phone is busy (individual settings for internal and external incoming calls).
- When you're not answering the phone (individual settings for internal and incoming calls).
- All the time.

You can enable different call forward modes independently. For example, you can set different phone numbers for Always, Busy Internal, Busy External, No Answer Internal, and No Answer External, and then turn them on/off individually.

Notes:

1. A **Call Forward Always** programmable key can be created that allows you quickly enable Always mode without having to enter the **Call Forward** settings menu. For more information on the **Call Forward Always** programmable key, see "[Call Forward Always](#)" on [page 54](#).
2. If voicemail is enabled, call forwarding numbers may already be defined by your System Administrator.

To configure call forward settings:

1. Press the  (**Settings**) key on the phone to enter the **Static Settings** menu.
2. Tap the **Call Forward** icon.

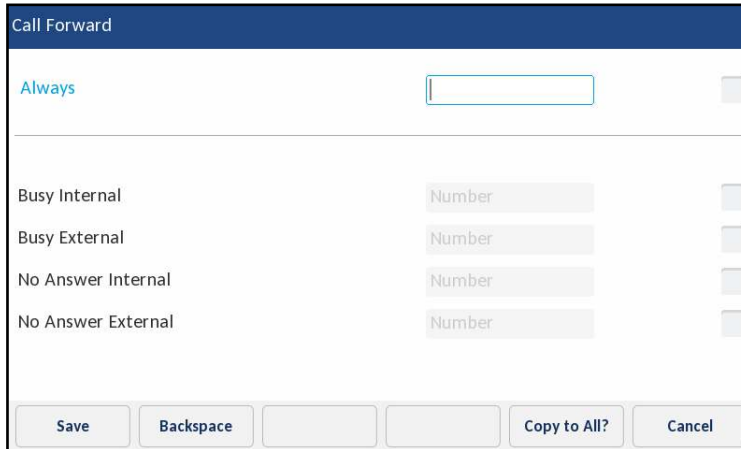

3. Tap the applicable **Number** input fields and enter forwarding numbers using the dialpad keys for any of the following states:
 - **Always:**
Immediately forwards all incoming calls to the specified number.
 - **Busy Internal:**
Immediately forwards internal phone calls if your line is busy.
 - **Busy External:**
Immediately forwards external phone calls if your line is busy.
 - **No Answer Internal:**
Forwards internal phone calls after several rings if you don't answer.
 - **No Answer External:**
Forwards external phone calls after several rings if you don't answer.

Note: Tapping the **Copy to All?** softkey copies the call forward number of the call forward mode in focus to every call forward mode. For example, if the cursor is on the **Busy Internal** field and the field has a phone number entered, tapping the **Copy to All?** softkey assigns the same phone number to all the other modes as well.

4. Tap the checkbox beside the respective call forward mode you want to use to enable the call forward mode.
5. Tap the **Save** softkey to save your changes.

Bluetooth

The Mitel MiVoice 6940 IP phone supports MobileLink, a feature that provides seamless mobile integration using Bluetooth wireless technology.

Note: For more information on how to use the MobileLink features, see “[MobileLink](#)” on [page 88](#).

The phone also supports the use of a Bluetooth headset or speakerphone as an alternate audio device. Using the **Bluetooth** settings menu, you can enable and disable Bluetooth functionality on your phone as required. You can also pair, connect, and unpair a Bluetooth device as applicable.

Notes:

1. The specific operation of third-party Bluetooth devices can vary somewhat by manufacturer and model. Ensure your Bluetooth device has been upgraded to its latest firmware revision. Refer to the documentation accompanying the Bluetooth device for details on operation, alerting tones, LEDs, and charging. Note that all Bluetooth devices will drop any call in progress if the maximum range is exceeded.
2. Only one Bluetooth device of each profile (i.e. handset, headset, mobile phone) can be connected at one time. Connecting to a new device of the same profile will automatically result in the disconnection of the previous device of the same profile. If there is no connection to any device (within the same profile) the phone will actively look for the most recently connected device and will attempt to automatically reconnect. Manually disconnecting the device using the device's native UI will not prevent an automatic reconnection. You must either disconnect using the **Bluetooth** menu on the Mitel MiVoice 6940 IP phone, "forget" the device, or the device must be out of range to circumvent the auto reconnect process.
3. Attempting to pair and connect using your Bluetooth device's respective menus may cause connectivity issues. Follow the procedures listed in the sections below to ensure the connectivity of your Bluetooth device.
4. When using a multi-point Bluetooth headset with your Mitel MiVoice 6940 IP phone, do not pair your multi-point Bluetooth headset to multiple devices (e.g. to your Mitel MiVoice 6940 IP phone and your mobile phone) as audio and connectivity issues may occur.
5. Some Bluetooth headsets have a proximity sensor feature that automatically changes the audio path depending on whether the headset is put on or taken off. It is strongly recommended to disable this feature when using the respective headset with the Mitel MiVoice 6940 IP phone as it may cause audio issues. Refer to the documentation accompanying the Bluetooth device for information on how to disable this feature.
6. Bluetooth headsets connected to the Mitel MiVoice 6940 IP phone are limited in functionality to answering, ending, and muting calls. Additional headset features (such as rejecting calls) are not supported and will cause unexpected behavior (e.g. invoking the reject call function will answer instead of reject).

Enabling Bluetooth functionality

To enable Bluetooth functionality:

1. Press the  (**Settings**) key on the phone to enter the **Static Settings** menu.
2. Tap the **Bluetooth** icon.

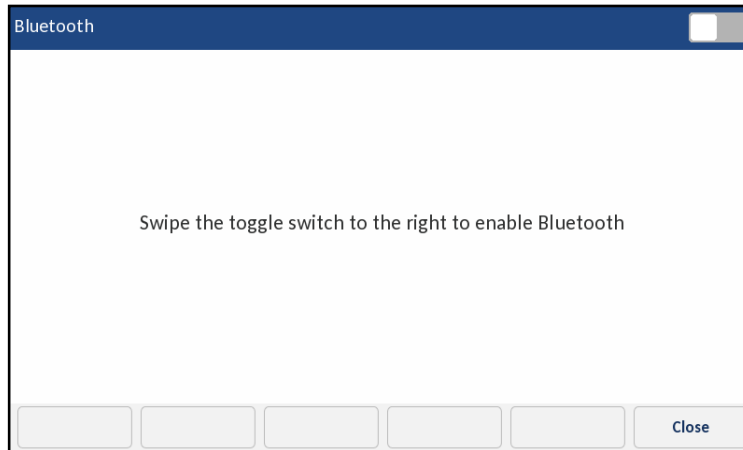

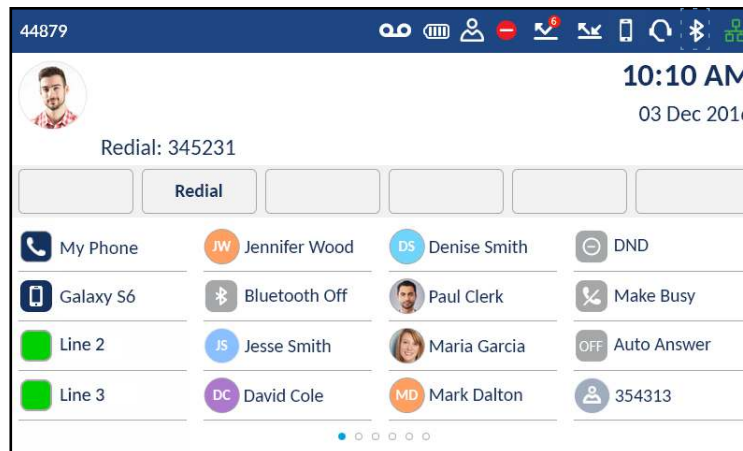

3. Swipe the Bluetooth toggle switch  to the right to enable Bluetooth functionality.

When Bluetooth functionality is enabled, a Bluetooth enabled icon  appears in the status bar on the **Home** screen.



Pairing a Bluetooth device

To pair a Bluetooth device:

1. Press the  (**Settings**) key on the phone to enter the **Static Settings** menu.
2. Tap the **Bluetooth** icon.
3. Ensure Bluetooth functionality is enabled. If it is not enabled, swipe the Bluetooth toggle switch  to the right to enable Bluetooth functionality.

4. If required, tap **Available Devices** to view the list of discoverable Bluetooth devices.

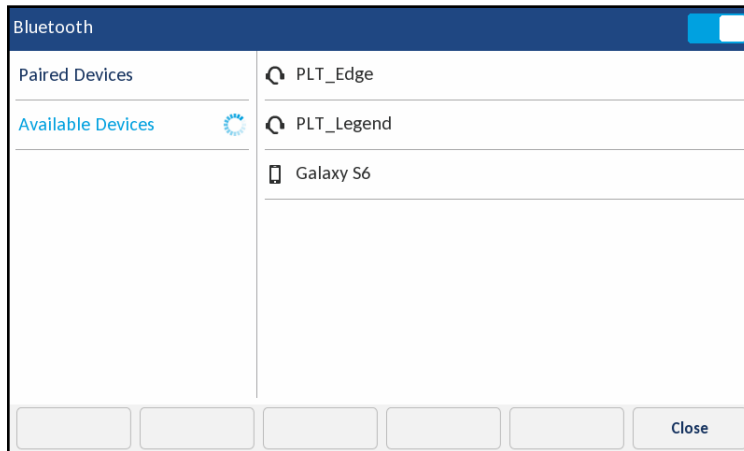

Note: The Mitel MiVoice 6940 IP phone scans for supported Bluetooth devices when viewing the list of available devices. Refer to the respective Bluetooth device documentation for discovery and pairing procedures that must be performed on your Bluetooth device.

5. Tap the Bluetooth device you want to pair to start the pairing process. The phone attempts to pair the Bluetooth device and if successful, automatically attempts to connect to the Bluetooth device.

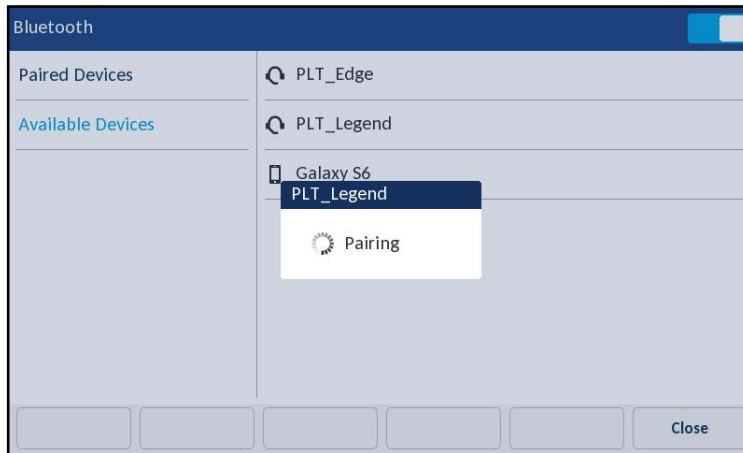

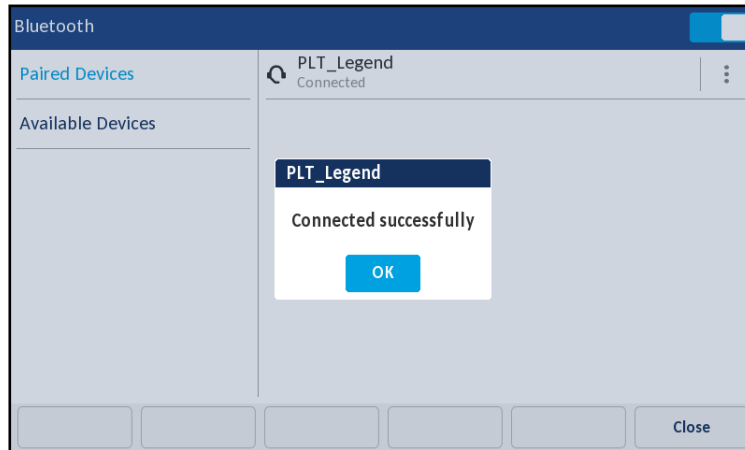

Notes:

1. The Bluetooth cordless handset included with the Mitel MiVoice 6940 IP phone comes automatically paired with the phone. If you need to pair the Bluetooth cordless handset again, power on the handset by placing the handset on the IP phone's cradle and follow the pairing procedures outline above. The handset's device name will appear in the available devices list as "Cordless Handset" followed by the last six digits of the handset's MAC address. For more information on the cordless Bluetooth handset, see ["Cordless Bluetooth handset"](#) on [page 14](#).
2. For mobile phones and some other Bluetooth devices, a Bluetooth pairing request displays on both the Mitel MiVoice 6940 IP Phone and the respective mobile phone or Bluetooth device. Ensure the pairing code matches on both devices and tap **Yes** on the Mitel MiVoice 6940 IP Phone and acknowledge the pairing request on your mobile phone or Bluetooth device.
3. If pairing or connecting fails, a failed error message displays on screen. Tap **Retry** to attempt to pair or connect again, or **Cancel** to cancel the attempt.
4. If pairing and connecting a mobile phone, depending on the connection state of the mobile phone, you may need to retry multiple times before the mobile phone pairs and connects successfully. Additionally, your Mitel MiVoice 6940 must be connected to the MiVoice Business phone system to pair and connect your mobile phone.





6. Tap **OK** to acknowledge the successful connection.
The MWI indicator flashes blue when successfully connected. The connected Bluetooth device is added to the list of **Paired Devices** and is ready to use.

When a Bluetooth headset is successfully connected, a Bluetooth headset connected icon  appears in the status bar on the **Home** screen. When a mobile phone is successfully connected, a Mobile connected icon  appears in the status bar on the **Home** screen.

Forgetting a Bluetooth device

To forget a Bluetooth device:

1. Press the  (**Settings**) key on the phone to enter the **Static Settings** menu.
2. Tap the **Bluetooth** icon.
3. Ensure Bluetooth functionality is enabled. If it is not enabled, swipe the Bluetooth toggle switch  to the right to enable Bluetooth functionality.

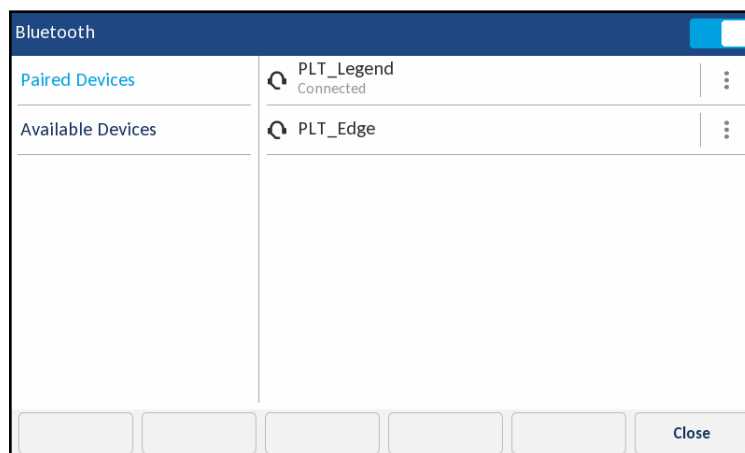

4. Tap the options icon beside the Bluetooth device you want to forget and tap the **Forget** softkey.

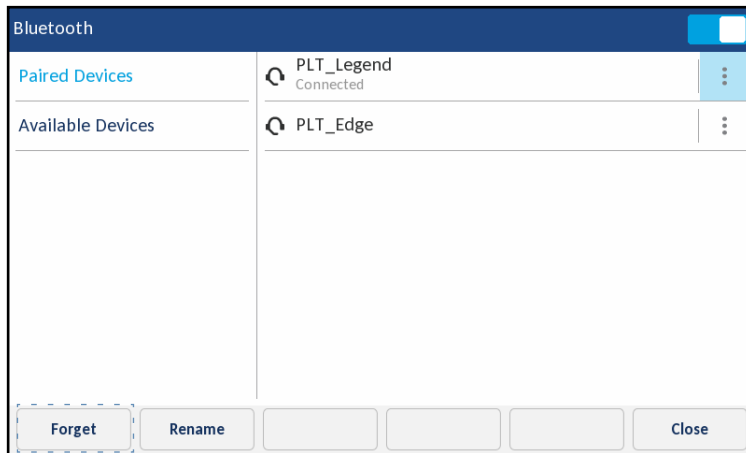

A confirmation message displays on screen.

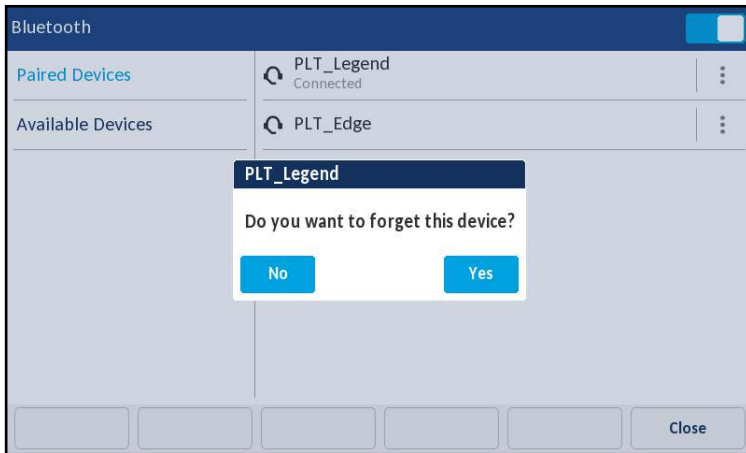

5. Tap **Yes** to forget the Bluetooth device.
The Bluetooth device is removed from the list of **Paired Devices**.

Disconnecting a connected Bluetooth device

To disconnect a connected Bluetooth device:

1. Press the  (**Settings**) key on the phone to enter the **Static Settings** menu.
2. Tap the **Bluetooth** icon.

3. Ensure Bluetooth functionality is enabled. If it is not enabled, swipe the Bluetooth toggle switch to the right to enable Bluetooth functionality.

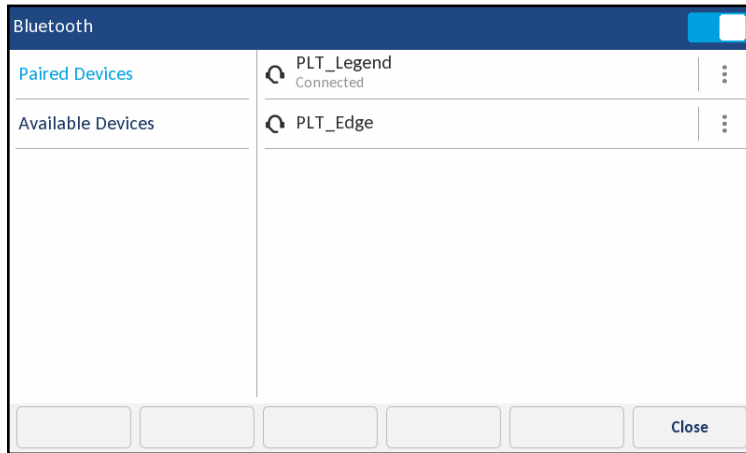

4. Tap the connected Bluetooth device you want to disconnect.
The Bluetooth device is disconnected.

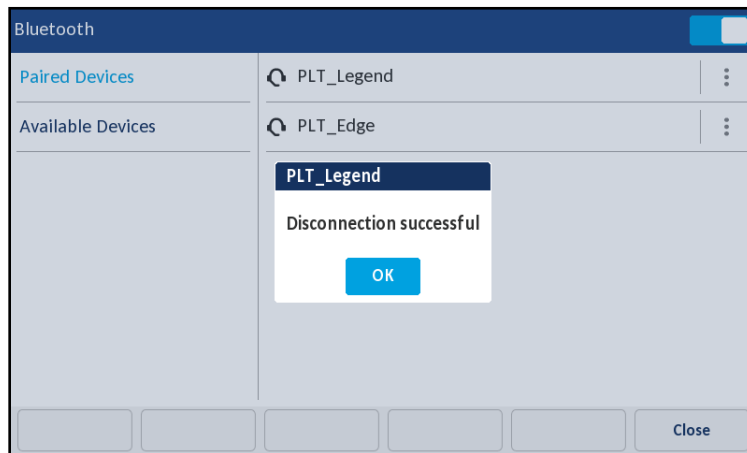

5. Tap the **OK** button to acknowledge the successful disconnection.

Renaming a paired Bluetooth device

To rename a paired Bluetooth device:

1. Press the  (**Settings**) key on the phone to enter the **Static Settings** menu.
2. Tap the **Bluetooth** icon.

3. Ensure Bluetooth functionality is enabled. If it is not enabled, swipe the Bluetooth toggle switch  to the right to enable Bluetooth functionality.

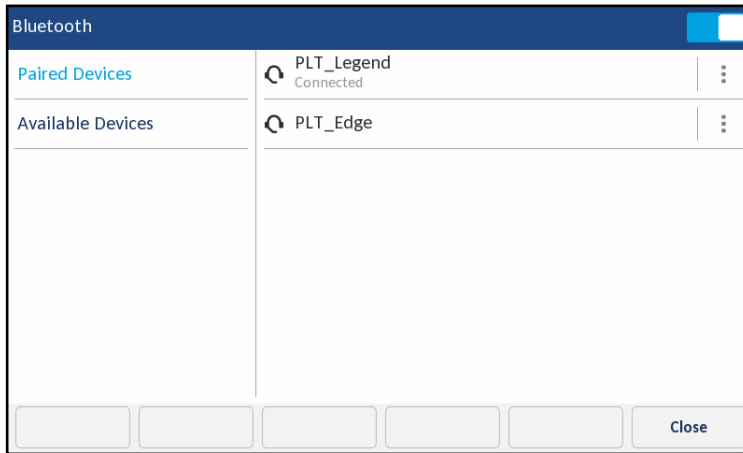

4. Tap the options icon beside the Bluetooth device you want to rename and tap the **Rename** softkey.

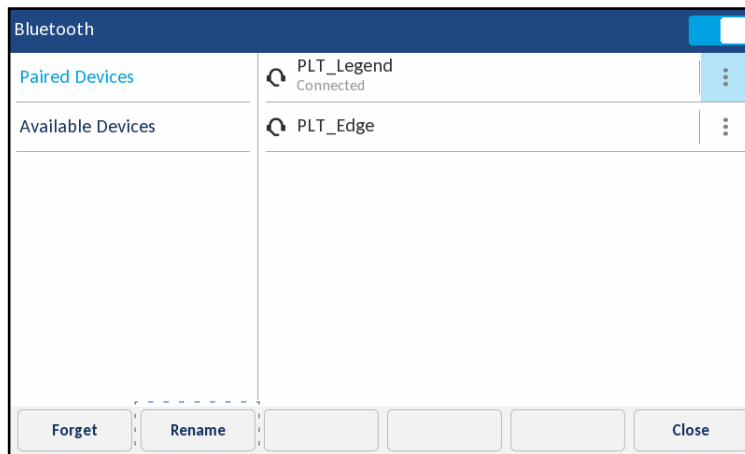

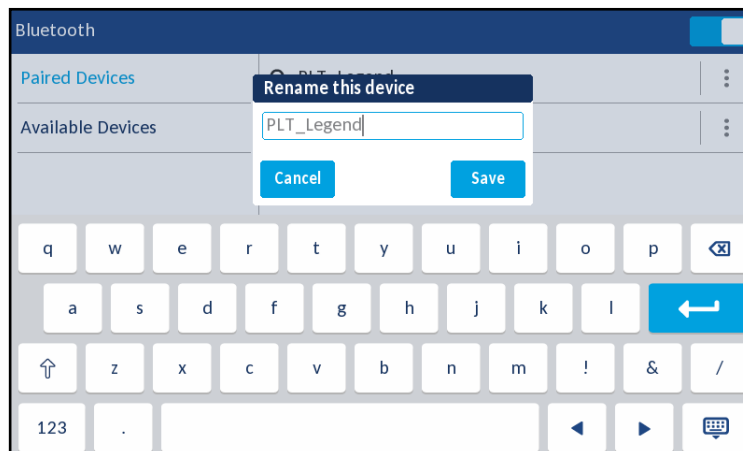

A pop up dialog appears allowing you edit the name of the Bluetooth device.



5. Edit the name of the device using the on-screen keyboard tap the **Save** softkey to save your changes.

Connecting to a different or disconnected Bluetooth device

To connect to a different or disconnected Bluetooth device:

1. Press the  (**Settings**) key on the phone to enter the **Static Settings** menu.
2. Tap the **Bluetooth** icon.
3. Ensure Bluetooth functionality is enabled. If it is not enabled, swipe the Bluetooth toggle switch  to the right to enable Bluetooth functionality.

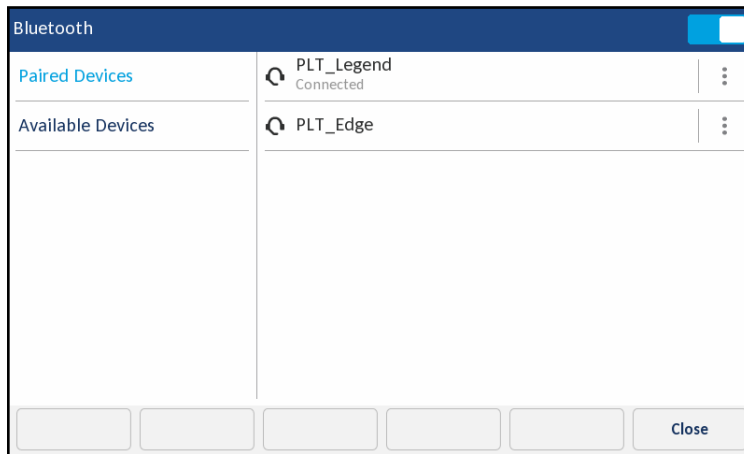

4. Tap the applicable Bluetooth device you want to connect to. The phone attempts to connect to the device.

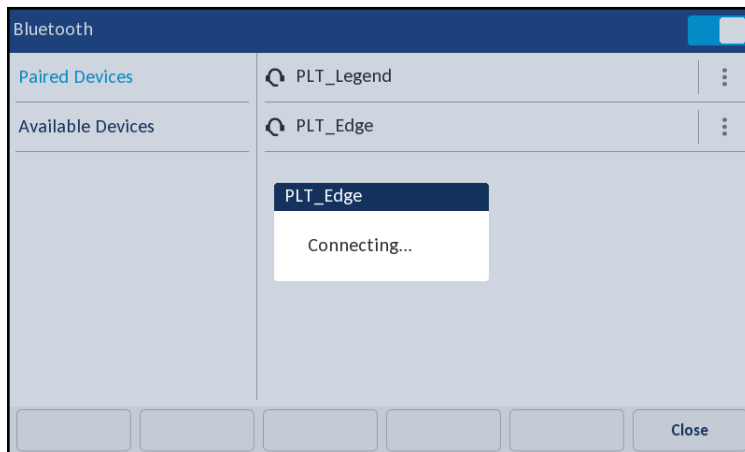

Notes:

1. If connecting fails, an error message displays on screen. Tap **Retry** to attempt to connect again, or **Cancel** to cancel the attempt.
2. If connecting a mobile phone, depending on the connection state of the mobile phone, you may need to retry multiple times before the mobile phone connects successfully. Additionally, your Mitel MiVoice 6940 must be connected to the MiVoice Business phone system to connect your mobile phone.

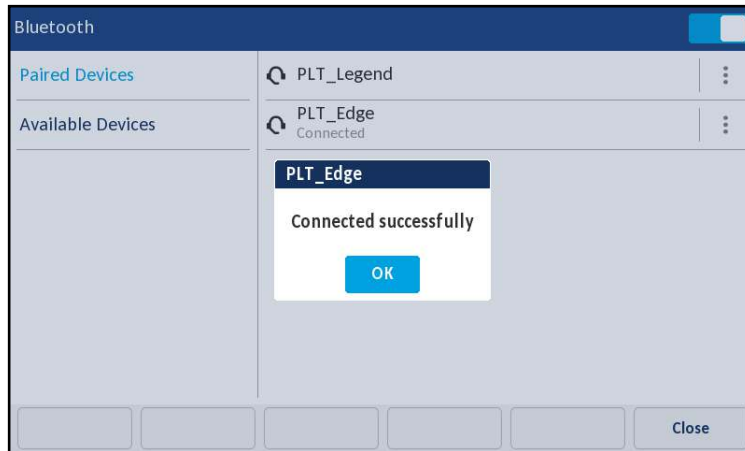

5. Tap the **OK** button to acknowledge the successful connection. The MWI indicator flashes blue when successfully connected. The connected Bluetooth device is ready to use.

Audio

The **Audio** setting on the Mitel MiVoice 6940 IP phone allows you to personalize ring tones and select the initial audio path used when pressing the  (**Speaker/Headset**) key.

Ring Tones

There are a total of 20 (10 modern and 10 classic) distinct ring tones available for selection on the Mitel MiVoice 6940 IP phone. Two different ring tones can be configured for incoming calls from internal numbers and external numbers.

To configure ringtones for internal and external calls:



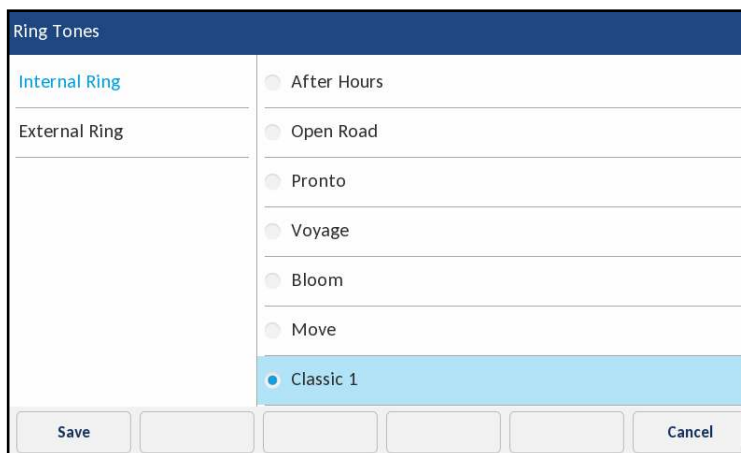

1. Press the  (**Settings**) key on the phone to enter the **Static Settings** menu.
2. Tap the **Audio** icon.
3. Tap the **Ring Tones** icon.



4. Swipe up and down to scroll through the list of internal ring tones and choose the applicable ring tone.
5. Tap **External Ring**.
6. Swipe up and down to scroll through the list of external ring tones and choose the applicable ring tone.
7. Press the **Save** softkey to save your changes.

Audio Path

The Mitel MiVoice 6940 IP phone allows you go "handsfree" when handling incoming and outgoing calls by supporting the use of a headset (USB or Bluetooth) or through speakerphone mode. The **Audio Path** setting allows you to choose the initial audio path used when pressing the  (**Speaker/Headset**) key. There are two audio path options that you can select:

Audio path	Description
Speaker	The default setting. When using the handset, pressing the  (Speaker/Headset) key on the phone switches to the speakerphone. Pressing the  (Speaker/Headset) key again switches to the headset (if connected). When using the speakerphone or headset, lift the handset to switch to the handset.
Headset	When using the handset, pressing the  (Speaker/Headset) key on the phone switches to the headset. Pressing the  (Speaker/Headset) key again switches to the speakerphone. When using the headset or speakerphone, lift the handset to switch to the handset.

To configure the audio path:

1. Press the  (**Settings**) key to enter the **Static Settings** menu.
2. Tap the **Audio** icon.
3. Tap the **Audio Path** icon.

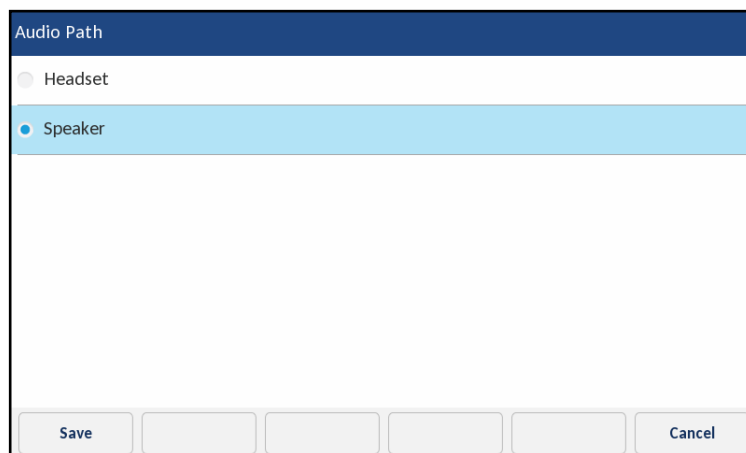

4. Tap the applicable audio path (**Speaker** or **Headset**).
5. Tap the **Save** softkey to save your changes.

Display

The **Display** setting allows you to set the following on your phone:

- **Brightness Settings:**
The **Brightness Level** setting on the Mitel MiVoice 6940 IP phone allows you to set the amount of light that illuminates the LCD display.
- **Screen Saver Settings:**
The **Screen Saver Timer** setting allows you to configure the amount of time (from 1 to 90 minutes) the phone must be idle before the screen saver starts. When the specified amount of time expires, a screen saver displaying the date and time and the number of missed calls (if applicable) is displayed on screen.



The **Dimmer Level** setting defines how brightly you want the screen to be illuminated when the screen saver is displayed.

Note: Availability of the above display settings is dependent on how your account is configured on the MiVoice Business call server.

To configure the display settings:

1. Press the  (**Settings**) key on the phone to enter the **Static Settings** menu.
2. Tap the **Display** icon.

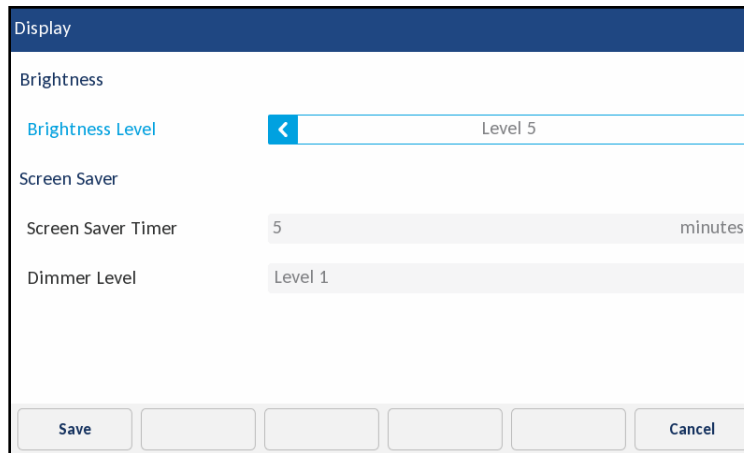

3. Tap the left and right arrow buttons in the **Brightness Level** field to increase or decrease the intensity of brightness on the LCD (valid values are from Levels 1 (darkest) to 5 (brightest)).
4. Tap the **Screen Saver Timer** field.
5. Enter a value, in minutes, using the dialpad keys. You can set the timer from 1 to 90 minutes. The default is 5 minutes.
6. Tap the **Dimmer Level** field.
7. Tap the left and right arrow buttons in the **Brightness Level** field to increase or decrease the intensity of brightness on the LCD when the screen saver is displayed (valid values are from Levels 0 (LCD off) to 5 (brightest)).
8. Press the **Save** softkey to save your changes.

Config Teleworker

The Mitel MiVoice 6940 IP phone can be configured to work in teleworker mode, which allows remote workers access to the same rich communications capabilities as in-office workers when using the IP phones.

The **Config Teleworker** menu allows you to enter the IP address of the server providing the teleworker configuration details.

To enter the IP address of the teleworker configuration server on the Mitel MiVoice 6940 IP phone:

1. Press the  (**Settings**) key on the phone to enter the **Static Settings** menu.
2. Tap the **Advanced** softkey.
3. Input the Administrator password using the dialpad keys (default is 73738) and tap the **Enter** softkey.
4. Tap the **Network** icon.

5. Tap the **Config Teleworker** icon.

Mitel MiVoice 6940 Config Teleworker

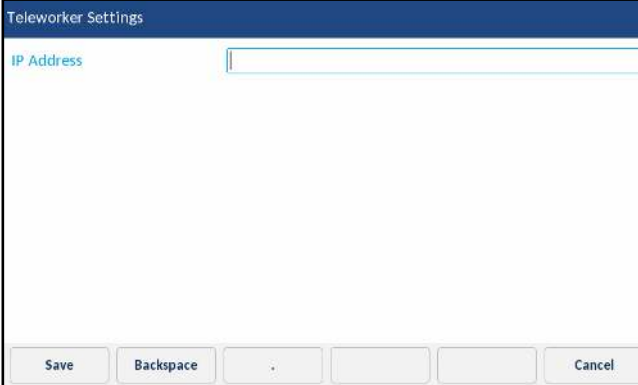

6. Enter the IP address of the server providing the teleworker configuration details in the **IP Address** field using the dialpad keys.

Note: The **Backspace** softkey can be used to delete the last digit/character entered and the dot (".") softkey can be used to enter a dot where applicable.

7. Tap the **Save** softkey to save your changes.

Diagnostics

The **Diagnostics** menu allows you to perform the following diagnostic routines:

- Audio Diagnostics
- Ping
- TCP DUMP
- DHCP Trace

Audio Diagnostics

The **Audio Diagnostics** sub-menu allows you to collect up to 5 minutes of audio log files that can help to debug audio issues on the Mitel MiVoice 6940 IP phone.

To capture audio diagnostic logs on the Mitel MiVoice 6940 IP phone:

1. Press the  (**Settings**) key on the phone to enter the **Static Settings** menu.
2. Tap the **Diagnostics** icon.

3. Tap the **Audio Diagnostics** icon.

Mitel MiVoice 6940 Audio Diagnostics

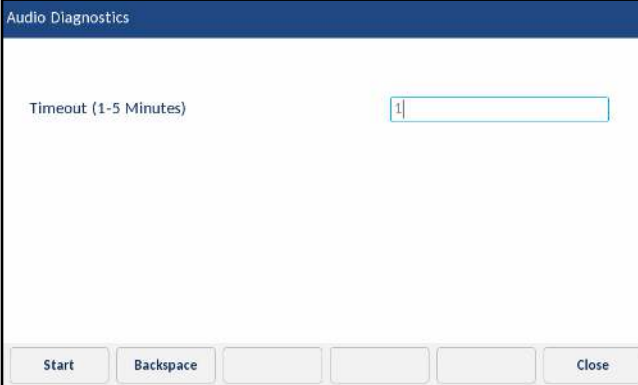

The screenshot shows a web-based interface for audio diagnostics. At the top, the title bar reads "Audio Diagnostics". Below the title bar, the text "Timeout (1-5 Minutes)" is displayed on the left, and an input field containing the number "1" is on the right. At the bottom of the interface, there are several softkey buttons: "Start", "Backspace", and "Close".

4. In the **Timeout** input field, enter the amount of time (in minutes from 1 to 5) you would like to run the audio diagnostic tool for using the dialpad keys.
The IP phone displays "Capturing..." and when the timeout elapses, "Collecting Logs..." is displayed. When all the logs have been collected, a "Complete..." message is displayed.

Note: Tap the **Stop** softkey at any time to stop capturing the audio diagnostic logs.

To save the audio diagnostic logs to your PC using the Mitel Web UI:

1. Open your web browser and enter the phone's IP address or host name into the address bar.
2. Enter your username and password and click **OK/Login**.
The status window displays for the IP phone you are accessing.

Note: The default username is "root" and the default password is "73738".

3. Click on **Diagnostics**.

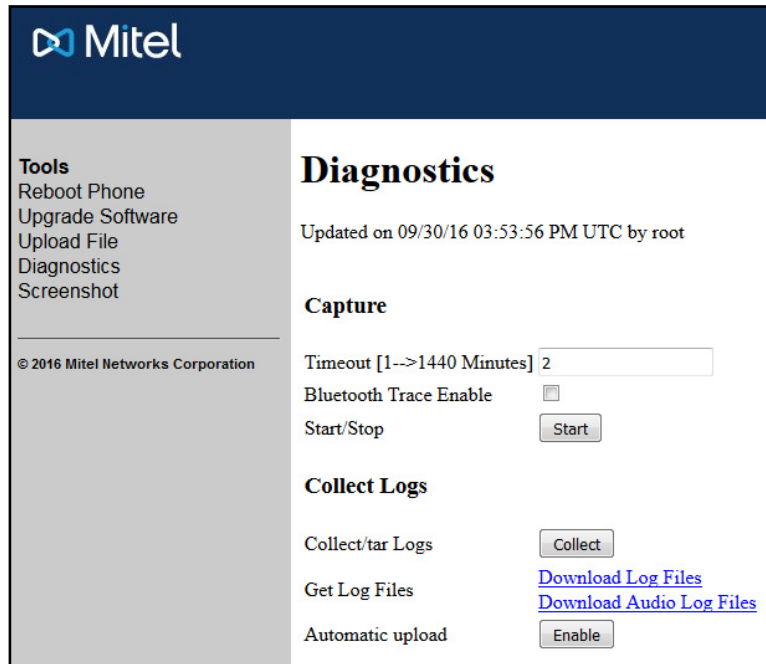

4. Click on the **Download Audio Log Files** link beside **Get Log Files**.
5. Save the file to the desired location on your computer.

Note: For more information on Mitel Web UI features, see the *Mitel MiVoice 6900 Series IP Phones Administrator Guide*.

Ping

The **Ping** sub-menu allows you to ping a host name or IP address directly from the Mitel MiVoice 6940 IP phone. This tool can be used to verify whether or not network connections between the Mitel MiVoice 6940 IP phone and other network endpoints are intact.

To use the ping tool on the Mitel MiVoice 6940 IP phone:

1. Press the  (**Settings**) key on the phone to enter the **Static Settings** menu.
2. Tap the **Diagnostics** icon.

3. Tap the **Ping** icon.

Mitel MiVoice 6940 Ping

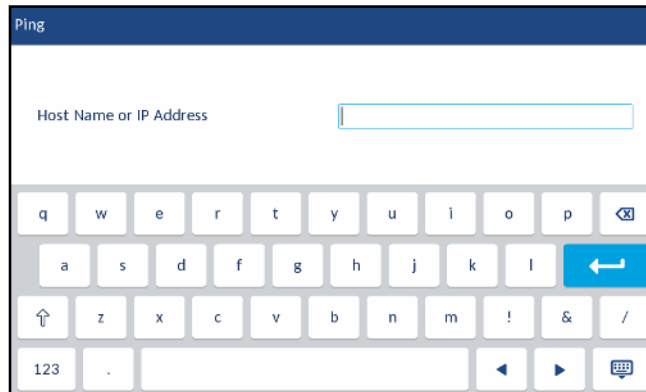

4. In the input field, enter the host name or IP address of the network endpoint you want to ping using the on-screen keyboard.
5. Tap the **Ping** softkey to begin.
The IP phone displays the number of packets sent, the number of packets received, and the Round-Trip Time (RTT) min/avg/max in milliseconds.

TCP DUMP

The **TCP DUMP** sub-menu allows you to capture TCP network packets for up to 1440 minutes (24 hours) that can in turn be used to help debug and troubleshoot various issues.

To capture TCP network packets on the Mitel MiVoice 6940 IP phone:

1. Press the  (**Settings**) key on the phone to enter the **Static Settings** menu.
2. Tap the **Diagnostics** icon.
3. Tap the **TCP DUMP** icon.

Mitel MiVoice 6940 TCP DUMP

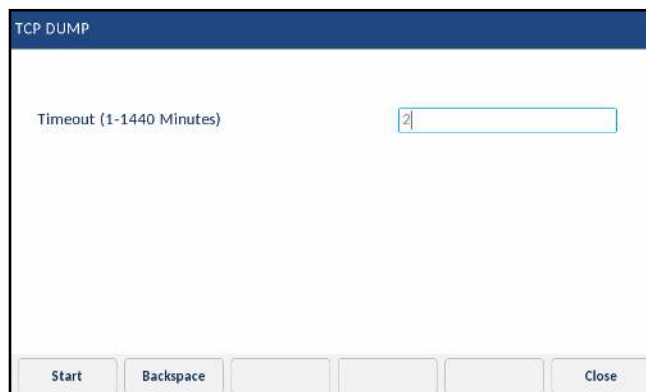

4. In the **Timeout** input field, enter the amount of time (in minutes from 1 to 1440) you would like to capture TCP network packet data using the dialpad keys.
The IP phone displays "Capturing..." and when the timeout elapses, "Complete..." is displayed.

Note: Tap the **Stop** softkey at any time to stop capturing the TCP DUMP logs.

To save the TCP network packet logs to your PC using the Mitel Web UI:

1. Open your web browser and enter the phone's IP address or host name into the address bar.
2. Enter your username and password and click **OK/Login**.
The status window displays for the IP phone you are accessing.

Note: The default username is "root" and the default password is "73738".

3. Click on **Diagnostics**.

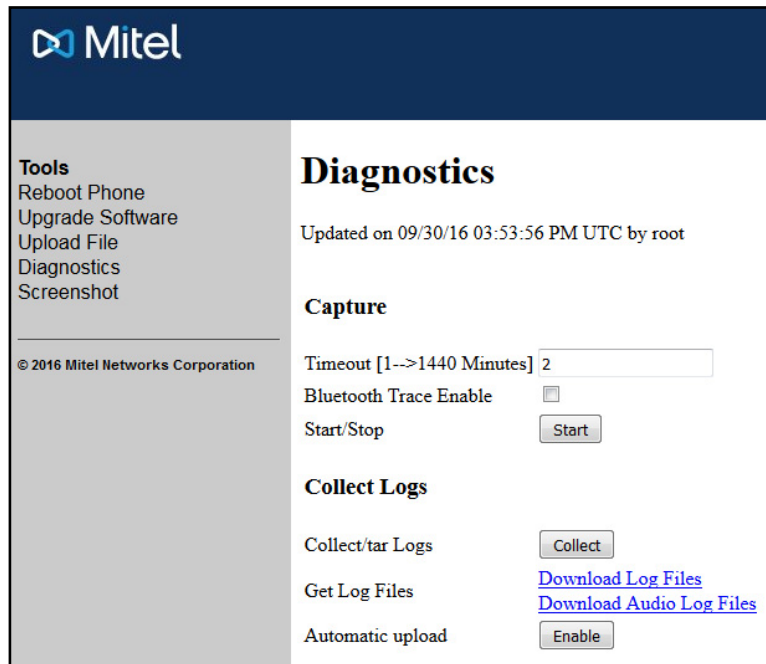

4. Click on the **Download Log Files** link beside **Get Log Files**.
5. Save the file to the desired location on your computer.

Note: For more information on Mitel Web UI features, see the *Mitel MiVoice 6900 Series IP Phones Administrator Guide*.

DHCP Trace

The **DHCP Trace** sub-menu allows you to perform a DHCP trace request. You can then review the parameters that the DHCP trace returns. After you have reviewed the trace information, the DHCP Lease is released.

To perform a DHCP trace on the on the Mitel MiVoice 6940 IP phone:

1. Press the  (**Settings**) key on the phone to enter the **Static Settings** menu.
2. Tap the **Diagnostics** icon.

3. Tap the **DHCP Trace** icon.

Mitel MiVoice 6940 DHCP Trace



The following parameters and associated values are displayed:

- **mac_addr:**
The MAC address of the IP phone.
- **ip addr:**
The IP address of the IP phone.
- **netmask:**
The IP address range local to the IP phone.
- **gateway:**
The IP address of the network's gateway or default router IP address.
- **dns:**
The IP address of the primary DNS server.
- **icp:**
The IP address of the MiVB call server.
- **tftp:**
The IP address of the TFTP server.
- **http:**
The IP address of the HTTP server.
- **ipa:**
The IP address of the IPA server.
- **VLAN:**
The VLAN id of the IP phone.
- **l2p:**
L2P priorities for default, voice, signaling, and other.
- **dscp:**
DSCP values for default, voice, signaling, and other.

Restart

The **Restart** setting allows you to restart your phone. You may need to restart your phone if you have been asked to do so by your System Administrator should you experience any unexpected behavior.

To restart your phone:

1. Press the  (**Settings**) key on the phone to enter the **Static Settings** menu.
2. Tap the **Restart** icon.

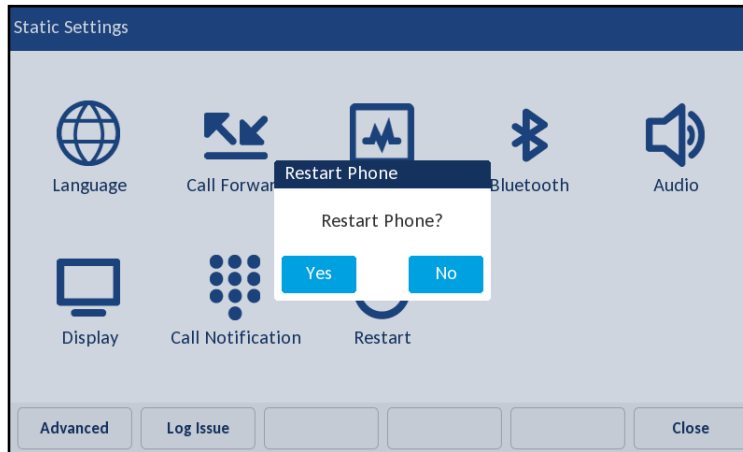

3. When the prompt, **Restart Phone?** appears, tap **Yes** to restart the phone. If you do not wish to restart your phone, press **No** or the **Cancel** softkey.

Note: Your phone will be temporarily out of service during the restart process.

Configuring and using programmable keys

Your Mitel MiVoice 6940 IP phone has 96 (16 visible at one time) programmable, multi-function, self-labeling keys allowing you to program and use up to 96 functions.

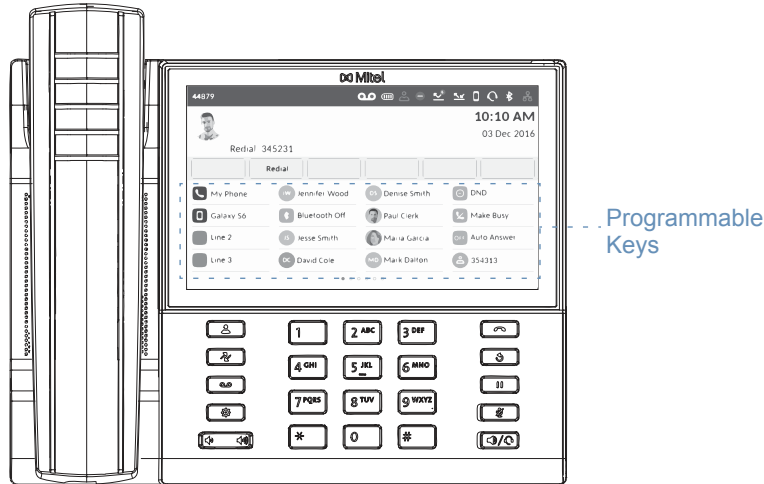

Notes:

1. If Mitel M695 Programmable Key Modules (PKMs) are attached to the phone, you can configure up to an additional 28 keys on each PKM.
2. The Mitel MiVoice 6940 IP phone allows up to three PKMs on each phone. For more information about PKMs, see “[Mitel M695 Programmable Key Module \(PKM\)](#)” on [page 97](#).

If enabled by your System Administrator, you can program or edit the following functions on the programmable keys by pressing and holding the respective programmable key for approximately four seconds:

Function	Default label
Speed Call	N/A
Phone Lock	Phone Lock
Call Forward Always	Fwd Always
Do Not Disturb	DND
Account Code Non Verified	Acct Non-Ver
Account Code Verified	Acct Verified

Note: Programming keys using the press-and-hold method is dependent on your Class of Service settings defined for your account on the MiVoice Business call server.

Speed Call

The **Speed Call** key allows you to dial a specified number with one tap of the key. **Speed Call** keys can be useful as they can be programmed to dial external numbers, dial directly to another person's extension or quickly access features that use feature access codes. You can also transfer calls to or create conference calls using your **Speed Call** keys in place of dialing out manually.

To program or edit a **Speed Call** key:

1. Press and hold the applicable programmable key for four seconds.

The screenshot shows a 'Programmable Key' configuration window. On the left, there is a menu with 'Speed Call' selected, 'Other Features', and 'More ...'. The main area is divided into two sections: 'Label Name' with a text input field, and 'Number' with a numeric keypad input field. Below the 'Number' field is a 'Private' checkbox. At the bottom, there are six softkey buttons: 'Save', 'Backspace', 'Pause', 'Flash', an empty button, and 'Cancel'.

2. In the **Label Name** field, enter a label to apply to the key using the on-screen keyboard.
3. Tap the **Number** field and enter a number using the dialpad keys.
4. (Optional) Tap the **Private** checkbox to make the key a **Private Speed Call** key. When a **Private Speed Call** key is tapped, the call is considered private and caller ID information is not displayed in the phone's call history.
5. Tap the **Save** softkey to save the information to the key you selected.

To make a speed call, tap the key that you have programmed with **Speed Call** functionality.

Other Features

Phone Lock

By programming a **Phone Lock** key you can lock your phone to prevent the phone from being used or configured. **Phone Lock** prevents access to all the features on the phone, with the following exceptions:

- Unlocking the set via a user PIN.
- Hot Desk Login and Logout support.
- Emergency Call Notification support.

Phone Lock has no effect on incoming calls but restricts outgoing calls, with the following exceptions:

- Calls to emergency trunk routes.
- Local operators.

All hard keys on the device are disabled except for the dialpad and volume keys. All programmable keys and softkeys are disabled except for the **Phone Lock**, **Hot Desk**, and Emergency Notification feature access keys.

To program a **Phone Lock** key:

1. Press and hold the applicable programmable key for four seconds.
2. Tap **Other Features**.
3. Tap **Phone Lock**.

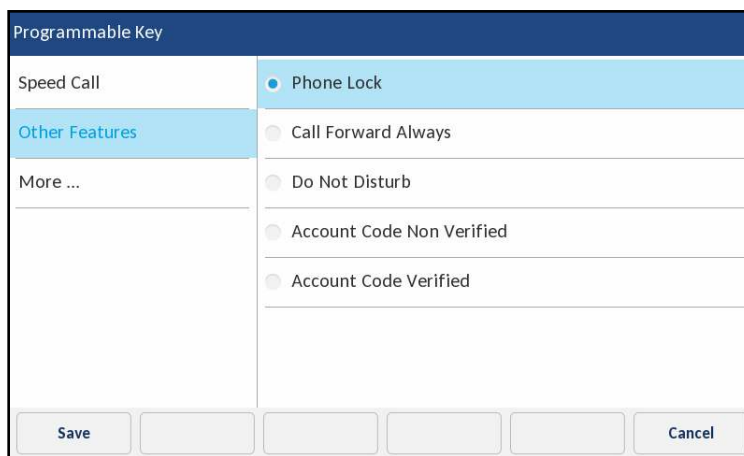

4. Tap the **Save** softkey.

To lock the phone:

1. Tap the **Phone Lock** key.
A "Locked" prompt appears on screen and the **Phone Lock** key turns light blue indicating the phone is locked.

To unlock the phone:

1. Tap the **Phone Lock** key again.
2. At the "Enter PIN:" prompt, enter your pin number using the dialpad keys and tap the **Enter** softkey.

Call Forward Always

Programming a **Call Forward Always** key allows you to quickly enable and disable call forwarding for all calls on your phone even if you have other call forward modes enabled through your **Call Forward** settings menu.

For example, you can enable settings to forward calls to your voicemail when your phone is busy or unanswered. Then, when you leave your desk, you can quickly enable **Call Forward Always** to forward calls to another phone, such as your home phone or cell. After you return to your desk and disable **Call Forwarding Always**, the defaults for busy or unanswered conditions remain active.

To program a **Call Forward Always** key:

1. Press and hold the applicable programmable key for four seconds.
2. Tap **Other Features**.
3. Tap **Call Forward Always**.

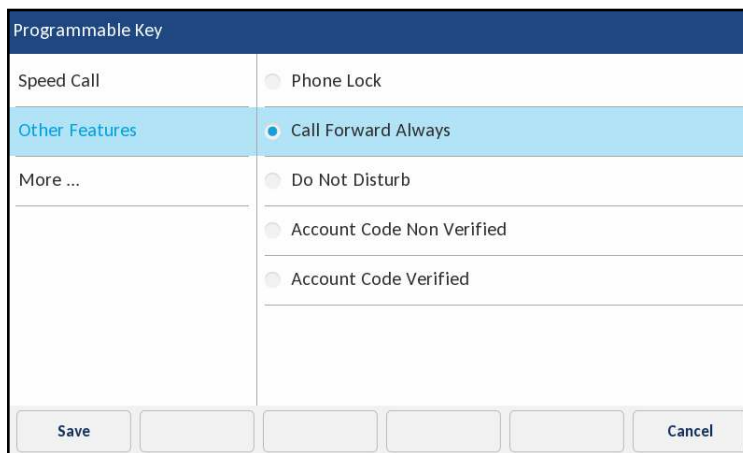

4. Tap the **Save** softkey.

To enable **Call Forward Always**:

1. Press the key that you have programmed with **Call Forward Always** functionality.
When Call Forward Always is enabled, a  (**Call Forward Always**) icon is displayed in the status bar.
2. If a number is already programmed, tap **Activate** to enable forwarding to the current number or
If a number has not been programmed, enter a new destination number using the dialpad keys and then tap the **Activate** softkey.

Note: When **Call Forward Always** is enabled, it takes precedence over all other types of call forwarding.

To disable **Call Forward Always**:

1. Press the key that you have programmed with **Call Forward Always** functionality.
When Call Forward Always is disabled, a  (**Call Forward Always**) icon is removed from the status bar.

2. Tap the **Deactivate** softkey.

Note: When **Call Forward Always** is disabled, the default call forwarding settings are active.

Do Not Disturb

When you program and enable a **Do Not Disturb** key, callers will get a busy tone and an on-screen text message indicating that you do not wish to be disturbed.

To program a **Do Not Disturb** key:

1. Press and hold the applicable programmable key for four seconds.
2. Tap **Other Features**.
3. Tap **Do Not Disturb**.

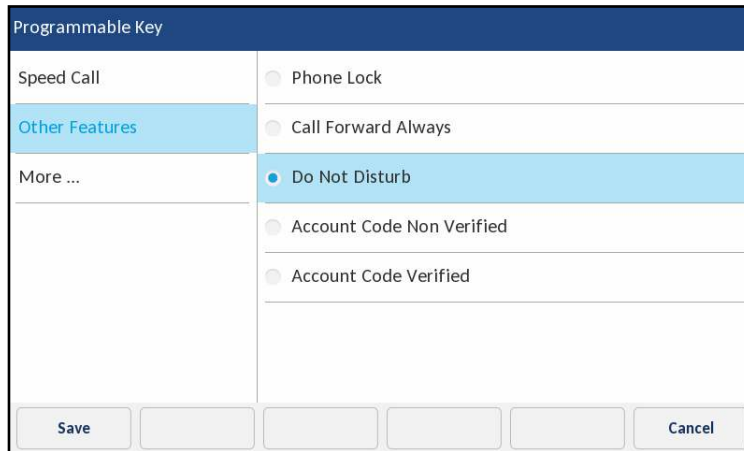

4. Tap the **Save** softkey.

To enable **Do Not Disturb**:

1. Tap the key that you have programmed with **Do Not Disturb** functionality. When DND is enabled, a **⊖ (DND)** icon is displayed in the status bar and the **Do Not Disturb** key turns red.

To disable **Do Not Disturb**:

1. Tap the key that you have programmed with **Do Not Disturb** functionality. When DND is disabled, the **⊖ (DND)** icon is removed from the status bar and the **Do Not Disturb** key returns to its normal color.

Account codes

Accounts codes are an effective way of grouping calls together for accounting, auditing, and reporting purposes. When you tag a call with an account code, the code is picked up in the records generated by your call server. This allows System Administrators the ability to quickly identify groups of calls, which can then be used by different departments for organizational and reporting purposes.

The following are the two types of account codes that you can add to a call:

- **Account Code Non Verified:**
A non-verified account code is one that has not been pre-programmed on your call server. Non-verified account codes can be used to group a set of calls that has not yet been verified and pre-programmed on your call server.
- **Account Code Verified:**
A verified account code is one that has been pre-programmed on your call server by a System Administrator.

Account Code Non Verified

To program an **Account Code Non Verified** key:

1. Press and hold the applicable programmable key for four seconds.
2. Tap **Other Features**.
3. Tap **Account Code Non Verified**.

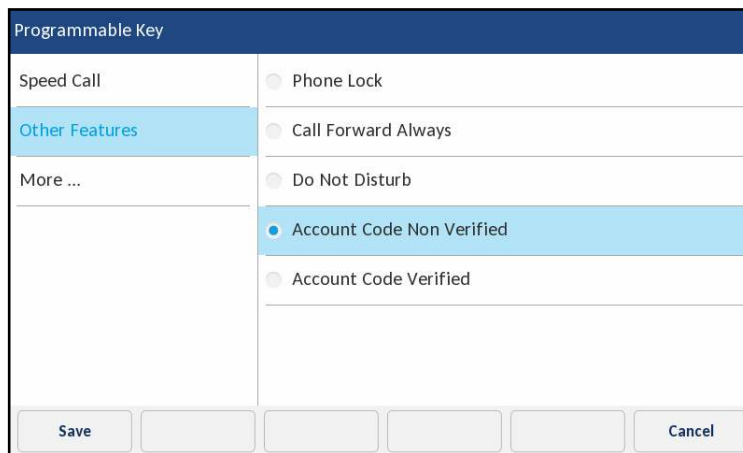

4. Tap the **Save** softkey.

To assign a non-verified account code before a call:

1. Tap the key that you have programmed with **Account Code Non Verified** functionality.
2. Enter the digits (up to 12) for the account code using the dialpad keys.
3. Press the # (hash) key.
4. Enter the number you wish to call.

To assign a non-verified account code during a call:

1. While on an active call, tap the key that you have programmed with **Account Code Non Verified** functionality.
2. Enter the digits (up to 12) for the account code using the dialpad keys.
3. Press the # (hash) key.

Account Code Verified

To program an **Account Code Verified** key:

1. Press and hold the applicable programmable key for four seconds.
2. Tap **Other Features**.
3. Tap **Account Code Verified**.

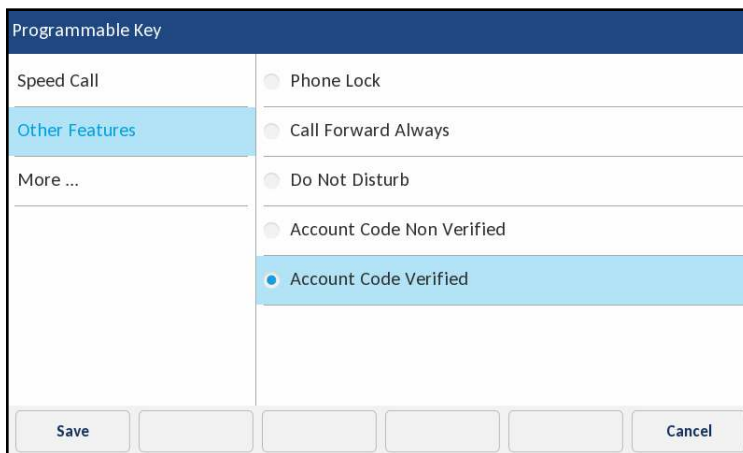

4. Tap the **Save** softkey.

To assign a verified account code before a call:

1. Tap the key that you have programmed with **Account Code Verified** functionality.
2. Enter the digits (up to 12) for the account code using the dialpad keys.
3. Press the # (hash) key.
4. Enter the number you wish to call.

To assign a verified account code during a call:

1. While on an active call, tap the key that you have programmed with **Account Code Verified** functionality.
2. Enter the digits (up to 12) for the account code using the dialpad keys.
3. Press the # (hash) key.

Making calls

This section describes ways to make calls on your Mitel MiVoice 6940 IP phone, using your handset, speakerphone or headset.

Dialing a number

First, take the phone off-hook by either:

- Lifting the handset (if the handset is on the cradle) for handset operation.
- Pressing the hookswitch key located on the side of the handset (if the handset is not on the cradle) for handset operation.
- Pressing the  (**Speaker/Headset**) key or tapping the applicable **Line** key for speaker or headset operation. Your phone must be configured to use the Speaker audio path for speaker operation or Headset audio path for headset operation.

At the dial tone, enter the number you wish to call. When your party picks up, a timer appears on your display that records the length of your call.

Alternatively, you can enter the number you wish to call without taking the phone off-hook. This method of dialing will use the speakerphone or headset audio path depending on the audio path setting you selected in the **Static Settings > Audio > Audio Path** menu. For more information, see the section “[Audio Path](#)” on [page 41](#).

Note: When dialing, press the **Backspace** softkey to delete the last digit entered. To cancel the dialing process, press the **End Call** softkey or the  (**Goodbye**) key.

If you are unable to make calls within certain area codes, check with your System Administrator for any toll restrictions placed on your extension that may restrict your access to long distance area codes or dialing prefixes.

Initiating a callback

The callback feature allows you to be notified when a busy phone becomes free or when a phone has been used after a no-answer condition was encountered.

To request a callback when the call you initiated is busy or has not answered:

1. Tap the **Call Me Back** softkey.
2. Hang up.

When the party is available, your phone starts ringing, and the display shows the callback ringing indicator.

To answer a callback when you see the callback ringing indicator:

1. Lift the handset, press the  (**Speaker/Headset**) key, or tap the applicable **Line** key.

Redialing a number

You can redial the most recently dialed number that is displayed on the **Home** screen by pressing the **Redial** hard key twice or by tapping the **Redial** softkey.

Pressing the **Redial** hard key once accesses the **Outgoing** calls list in the **Call History** application. For more information on the **Call History** application, see “[Call History](#)” on [page 80](#).

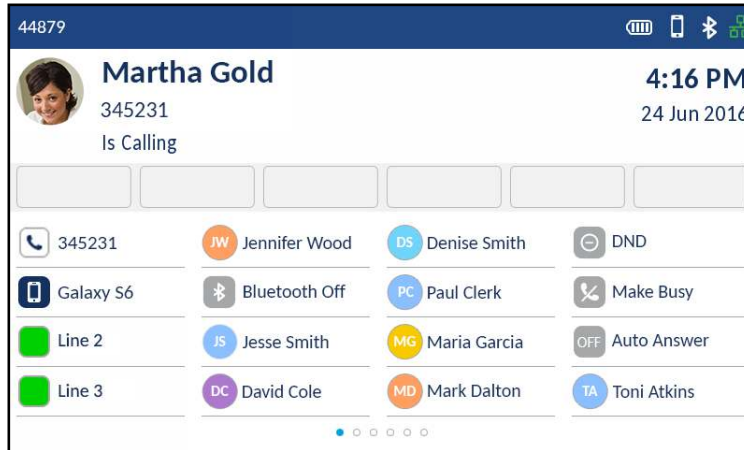

Receiving calls

When a call is ringing at your extension, the callers name, number, and avatar (if applicable) display on the **Call** screen. Additionally, the applicable **Line** key icon flashes indicating the incoming call.



Answering an incoming call

To answer an incoming call:

- If the handset is on the cradle, lift the handset for handset operation.
- If the handset is not on the cradle, press the hookswitch key located on the side of the handset for handset operation.
- For speakerphone operation, press the  (**Speaker/Headset**) key or tap the applicable **Line** softkey. Your phone must be configured to use the Speaker audio path.
- For headset operation, press the  (**Speaker/Headset**) key or the answer button on your headset (if available). Your phone must be configured to use the Headset audio path.

Note: The audio path setting you selected in the **Static Settings > Audio > Audio Path** menu determines if the call goes to the speakerphone or headset. For more information, see the section “Audio Path” on page 41.

Manually forwarding an incoming call

If call forwarding numbers have been defined for the **Always** or **No Answer** states, tap the **Forward Call** softkey to manually forward an incoming call to the defined number. A common way of using this feature is to configure call forwarding to forward calls to your voicemail service. You can then manually decide whether to answer an incoming call or send the call to voicemail.

Notes:

1. The number defined for the **Always** state has precedence over the numbers defined for the **No Answer** states.
2. For more information on how to configure the **Call Forward** feature, see the section “Call Forward” on page 29.



Handling calls

When you are connected to a call, you can use hard keys on the phone perform various action such as placing a call on hold or muting the microphone. Softkeys can also be used to perform actions such as transferring calls or creating multi-party conference calls.

Placing a call on hold

You can place an active call on hold by pressing the  (**Hold**) key.

To place a call on hold (while on an active call):

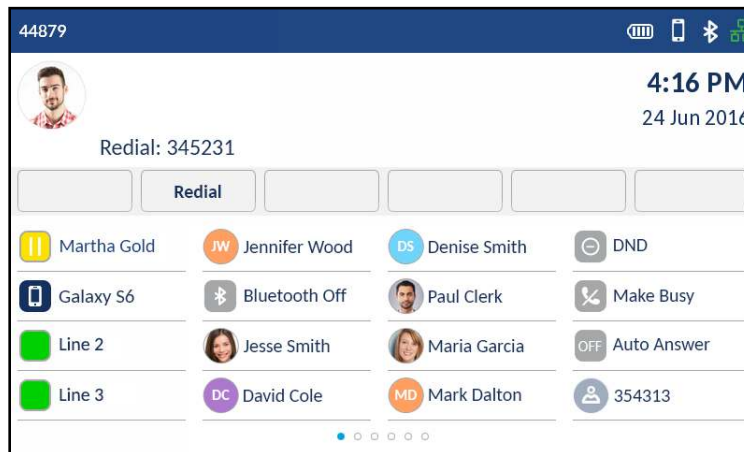

1. Press the  (**Hold**) key.
Your applicable **Line** key flashes the  (**Hold**) icon indicating the call is on hold. To let your caller know that they are on hold, music plays softly (if this has been set up on your call server).





Note: After a prolonged period of time on hold, the held call may automatically switch to an incoming call to remind you that the call was on hold.

2. To retrieve a call on hold tap the applicable **Line** key.

Muting the microphone

You can use the  (**Mute**) key to mute the microphone on the handset, headset, or speakerphone. When you use the  (**Mute**) key on your phone, you cannot be heard on an active call or on a conference.

You can also mute the microphone on the handset, by pressing the handset's mute key located between the handset's volume control keys.

To indicate a muted microphone, the LED beside the  (**Mute**) key turns on. To switch mute on or off, press the  (**Mute**) key.

Note: If you place a muted call on hold, the phone automatically takes the call off mute when you reconnect to the call.

Transferring a call

There are two types of call transfers that can be performed on the Mitel MiVoice 6940 IP phone:

- **Unattended Transfer:**
An unattended transfer is when you transfer a call directly to another extension without consulting with the person receiving the call. To do this, complete the transfer immediately after you have entered the number. The call goes directly to the extension or outside line to which you transferred.
- **Attended transfer:**
You also have the option to consult with the person to which you are transferring the call, before you complete the transfer. To do this, remain on the line until the receiving party answers the call. After consulting with the receiving party, you can either complete the transfer or cancel the transfer to go back to the original call.

To transfer a call:

1. Ensure you are on active call with the party you wish to transfer.

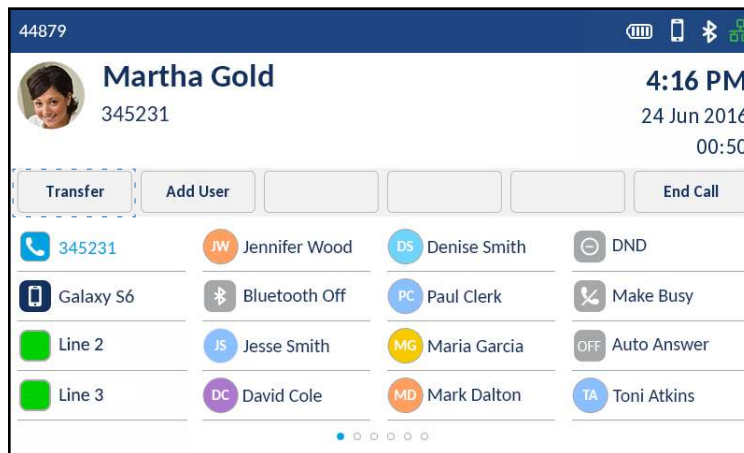

2. Tap the **Transfer** softkey.
The active call is placed on hold.

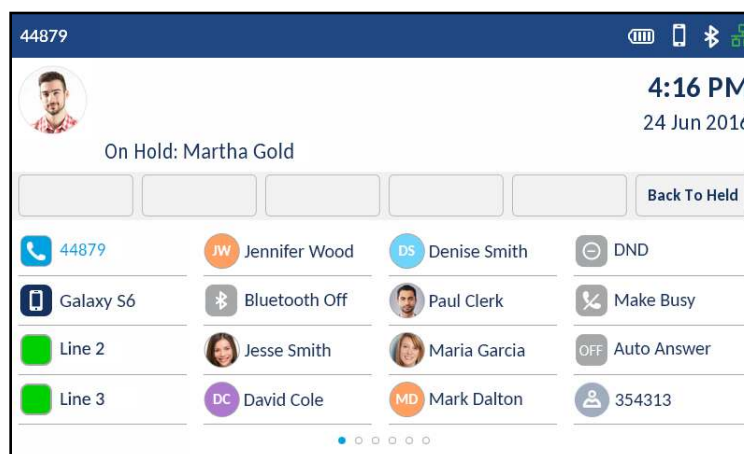

3. Enter the transfer recipient's number.

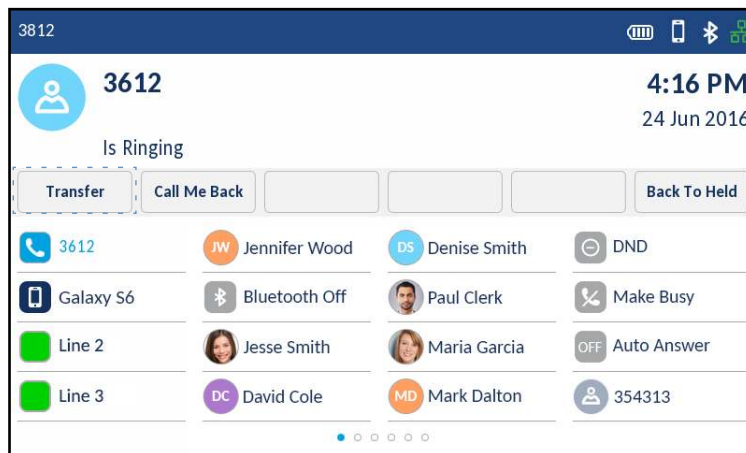

4. Tap the **Transfer** softkey or hang up the handset to complete an unattended call transfer
or
Wait for an answer, consult, and then tap the **Transfer** softkey or hang up the handset to complete an attended transfer.

Creating a multi-party conference call

The Mitel MiVoice 6940 IP phone supports multiples parties in a conference call.

To create a multi-party conference call:

1. Ensure you are on active call with one of the parties with whom you wish to create a conference.

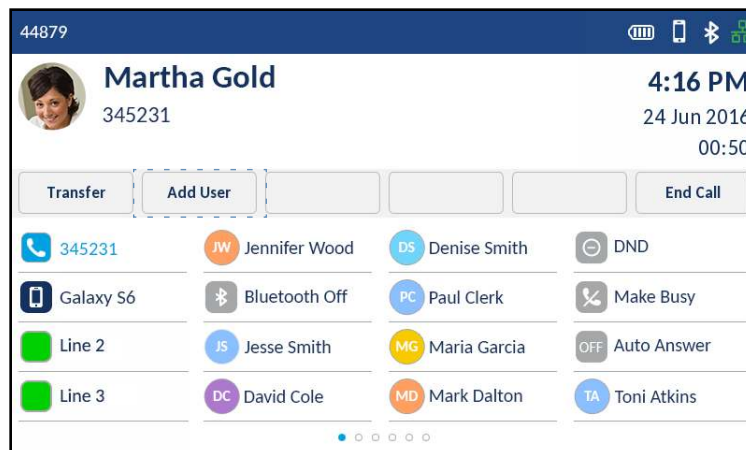

2. Tap the **Add User** softkey.
The active call is placed on hold.

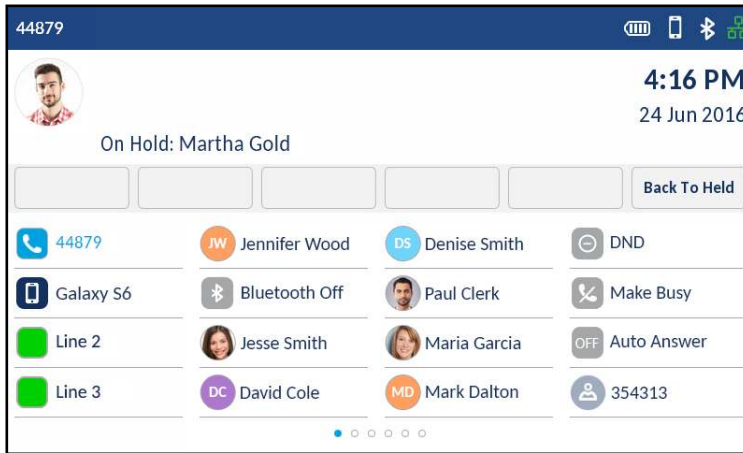

3. Enter the conference target's number.

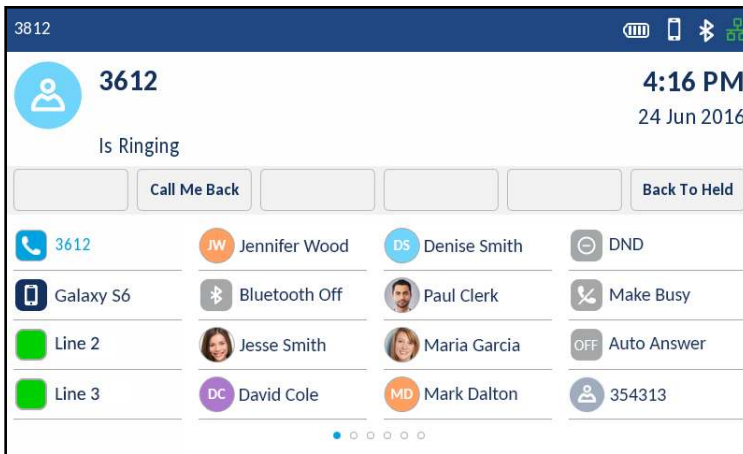

4. Wait for an answer, consult, and then tap the **Join Calls** softkey to create the three-way conference call.

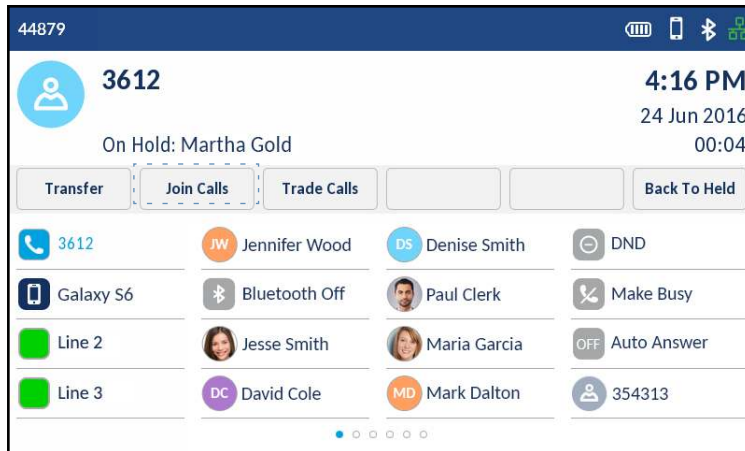

Notes:

1. Tapping the **Trade Calls** softkey swaps the active call with the other party currently on hold.
2. Tapping the **Split** softkey splits the conference call by placing all callers on hold except for the initial caller.

5. Repeat steps 2 to 4 to add additional parties to the conference.

Note: If you want to create a conference call with two parties you are already in calls with (on different line appearances), tap the **Add Held** softkey and then tap the applicable **Line** key with the held call.

Ending a conference and transferring remaining parties

The Mitel MiVoice 6940 IP phone allows a host to easily leave a conference call without disrupting the connection of the other remaining parties.

If you are the host of a conference call and want to leave the conference, tap the **Leave Call** softkey on the phone. Your phone leaves the conference call but the remaining parties are still connected together.

Ending calls

To end a call, you first need to connect or reconnect to the call if not already connected (e.g. if your caller is on hold). With the call connected, place the handset on its cradle, tap the **End Call** softkey, or press the  (**Goodbye**) key. Pressing the hookswitch button located on the side of the handset also ends an active call.

Managing calls

The Mitel MiVoice 6940 IP phone has several features that make it easier to manage calls. Three of the main call management features include the **Contacts** application, the **Call History** application, and **Voicemail**.

Contacts

The **Contacts** application is your personal phone book and directory, conveniently stored within your phone. The Mitel MiVoice 6940 IP phone supports a localized **Personal** contact folder as well as enhanced functionality allowing for interoperability with LDAP (**Corporate**) directories. The phone also supports MobileLink synchronization with mobile phone contact lists using Bluetooth capabilities.



Notes:

1. Access to Corporate directories must be set up by your System Administrator.
2. For more information on syncing mobile contacts and MobileLink functionality, see [“Syncing mobile contacts”](#) on page 89.

General functions

Accessing and navigating the Contacts application

To access and navigate the Contacts application:

1. Press the  (**Contacts**) key.

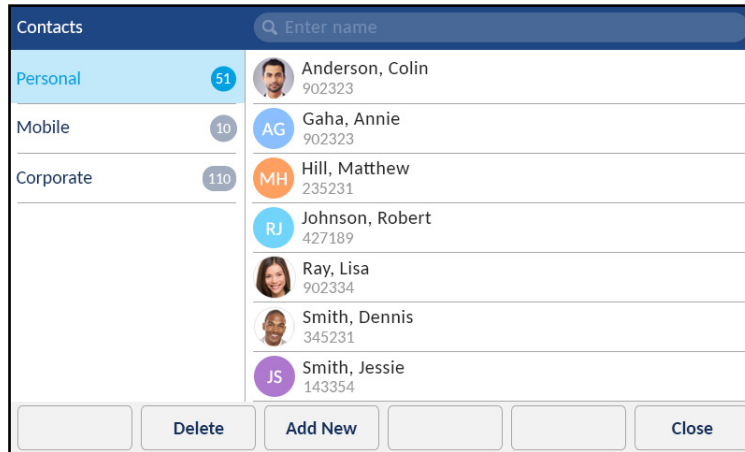

2. Tap the contact folder you wish to view.

Note: If any of the folders are empty, a "Directory empty" message displays on screen.

3. Swipe up and down to scroll through the list of contacts.
4. Tap to select a contact.

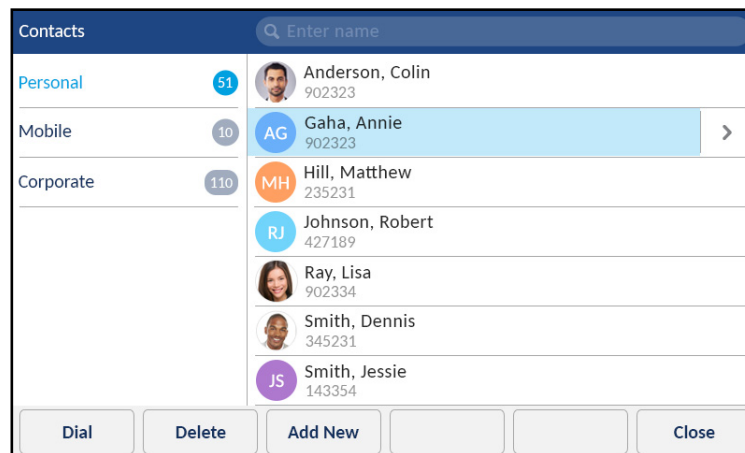

- With the respective contact selected, tap the right arrow button to view the contact's contact card.

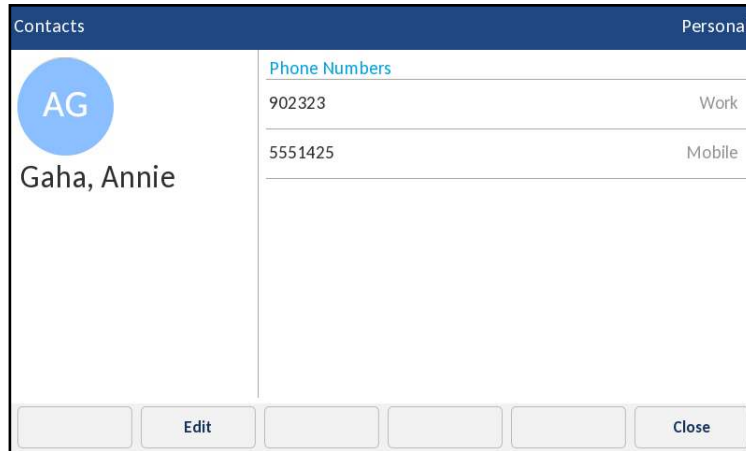

- Tap to select a number.
- Press the  (**Goodbye**) key, or **Close** softkey to exit.

Performing a search

Search functionality is applied to your **Personal** and **Mobile** contact folders and your **Corporate** contact folder if your corporate directory is configured to be cached.

Note: If you do not see a number indicating the amount of contacts beside your **Corporate** folder, your corporate directory is configured to be non-cached. See [“Performing a search on a non-cached Corporate contact folder”](#) on page 77 if your phone is configured to use a non-cached corporate directory.

Pressing on any dialpad key or tapping on the search bar initiates the search. After entering the first few letters of the contact's first name or last name and initiating the search, you can then quickly select a contact and perform the applicable action. Use the following procedure on the phone's UI to perform a search.

To perform a search:

- Press the  (**Contacts**) key.

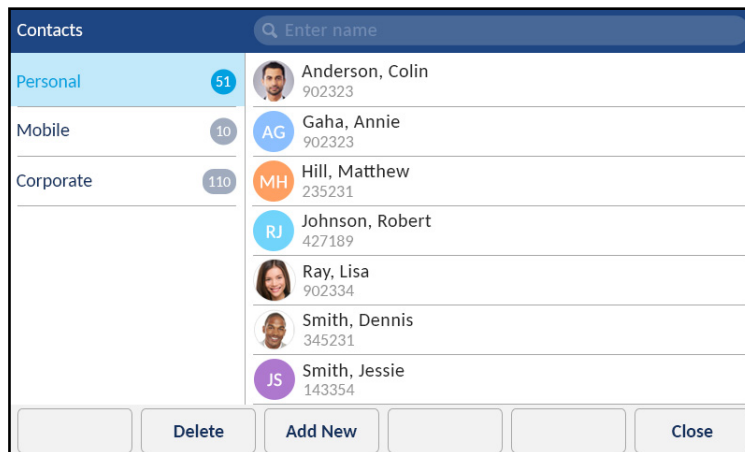

2. Tap the search bar.
3. Enter the first letters of the contact's name using the on-screen keyboard and (if required) tap the blue return button.

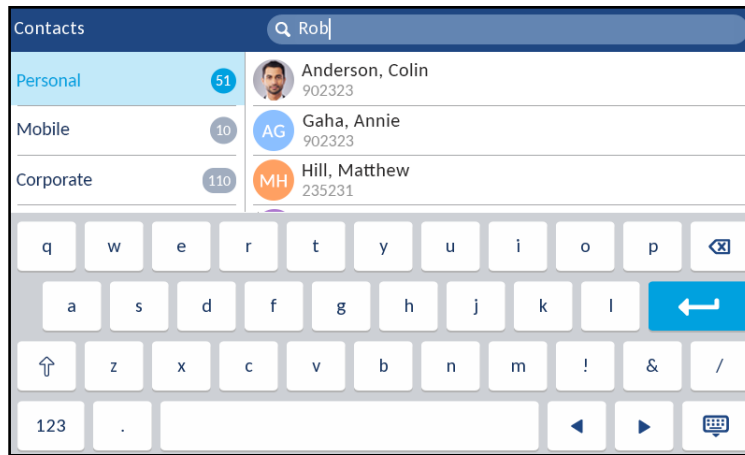

Note: Hide the keyboard and press the **Reset** softkey at any time clear the search field.

4. When matches are found, tap the applicable contact entry and perform your desired action.

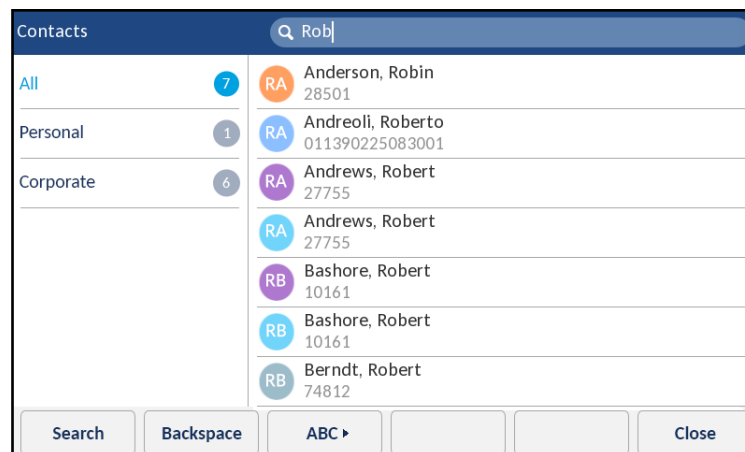



Dialing from the Contacts application

Dialing can be performed by manually navigating to the contact, selecting a phone number (if the contact has more than one) and then by picking up the handset, or by pressing the **Dial** softkey, **Select** button or  (**Speaker/Headset**) key.

To dial a contact's phone number.

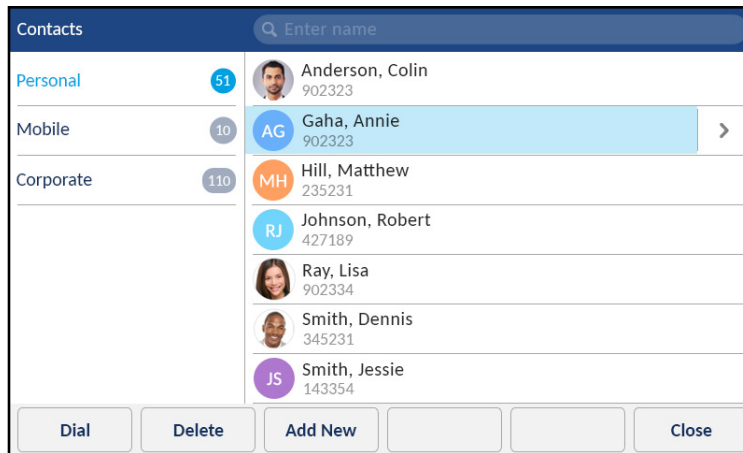
1. Press the  (**Contacts**) key.
2. (Optional) Tap the search bar, enter the first letters of the contact's name, and tap the blue return button to initialize the search function.
3. Tap the contact you want to call.



4. (Optional) If the contact has multiple phone numbers defined, press the right arrow button to navigate to the contact card and tap the phone number you wish to call.
5. Tap the **Dial** softkey or press the  (**Speaker/Headset**) key for speaker or headset operation or
Pickup the handset for handset operation.

Personal folder features

The **Personal** folder contains the contacts that have been created or copied directly to the phone using the phone UI.

From the **Personal** folder you can search for a personal contact, place a call to the selected personal contact, add new personal contacts, delete all personal contacts, delete individual personal contacts, or edit existing personal contacts. You can also view contact details (e.g. avatar, name, and numbers) by navigating to the contact card.

Adding a new contact to your Personal folder

To add a new contact to your **Personal** folder:

1. Press the  (**Contacts**) key.
2. Tap the **Add New** softkey.

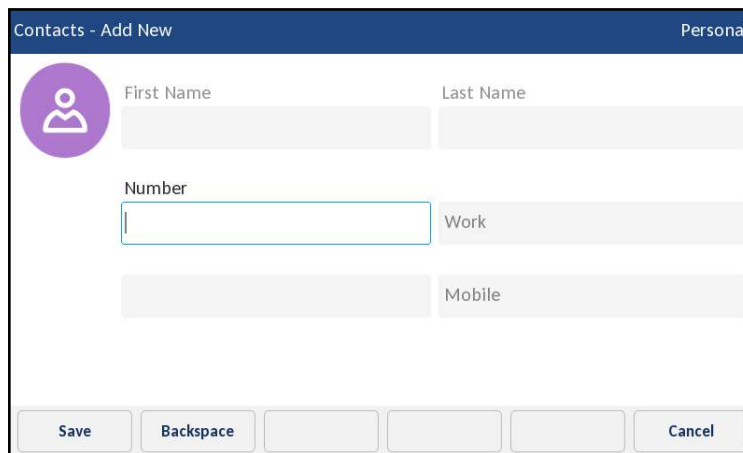

The screenshot shows the 'Contacts - Add New' screen. The title bar is dark blue with 'Contacts - Add New' on the left and 'Personal' on the right. Below the title bar is a purple circular icon with a white person silhouette. To the right of the icon are two input fields: 'First Name' and 'Last Name'. Below these are two more input fields: 'Number' and 'Work'. Below 'Work' is a 'Mobile' input field. At the bottom of the screen are several buttons: 'Save', 'Backspace', and 'Cancel'.

3. Tap the **First Name** input field and enter the first name of the personal contact using the on-screen keyboard.

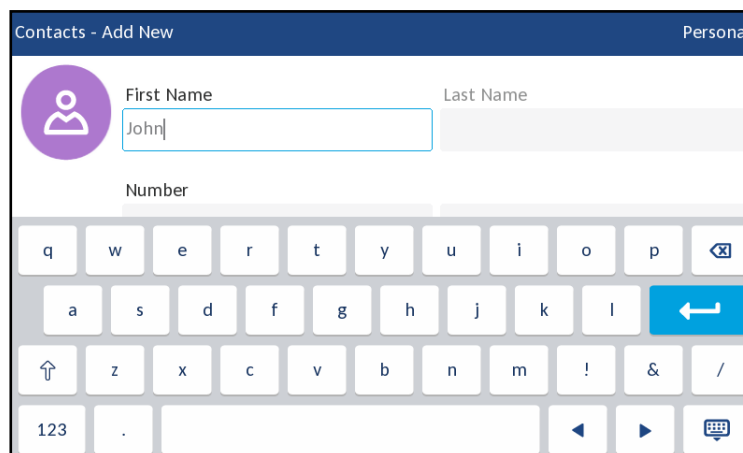

This screenshot is similar to the previous one, but the on-screen keyboard is now open. The 'First Name' input field contains the text 'John'. The keyboard has a blue back arrow key on the right side.

4. (Optional) Tap the **Last Name** input field and enter the last name of the personal contact using the on-screen keyboard.

5. Tap the initial **Number** input field and enter the number of the personal contact using the dialpad keys.

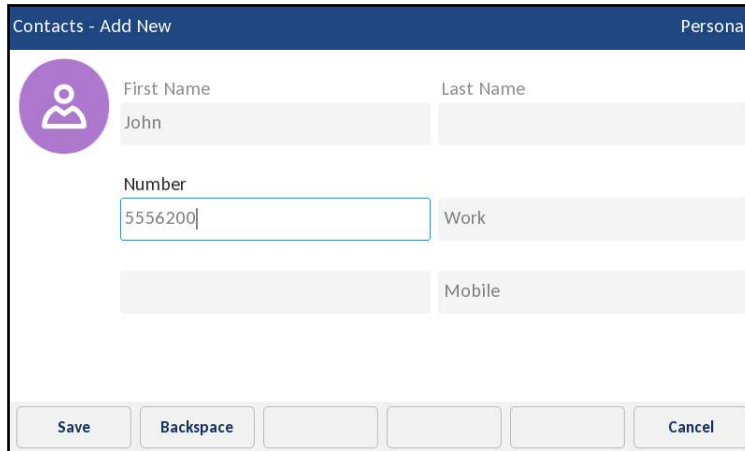

The screenshot shows the 'Contacts - Add New' screen with a 'Personal' folder selected. The form includes fields for 'First Name' (John), 'Last Name', 'Number' (5556200), 'Work', and 'Mobile'. The 'Number' field is highlighted with a blue border. At the bottom, there are 'Save', 'Backspace', and 'Cancel' buttons.

6. Tap the number type (Work/Home/Mobile) field and tap the left and right arrow buttons to switch the type of number (either Work, Home, or Mobile).

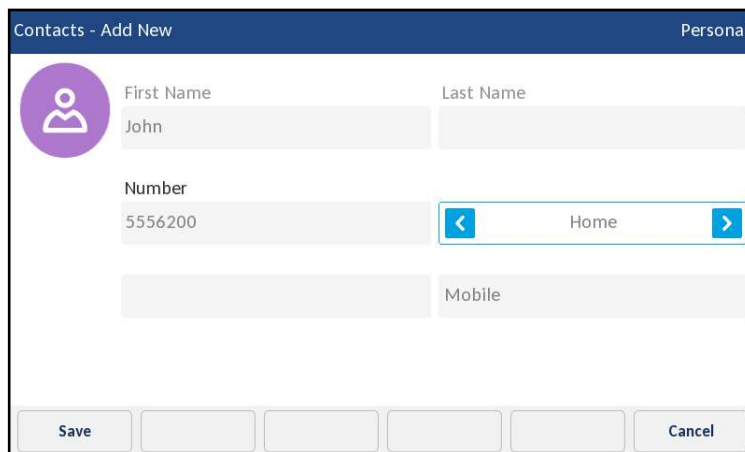

The screenshot shows the 'Contacts - Add New' screen with the 'Number' field set to '5556200'. The 'Work' type is selected, and the field is surrounded by left and right arrow buttons. At the bottom, there are 'Save' and 'Cancel' buttons.

7. (Optional) Repeat steps 5 and 6 to enter a secondary number.
8. Tap the **Save** softkey to save the contact to your **Personal** folder.

Editing an existing contact in your Personal folder

To edit an existing contact in your **Personal** folder:

1. Press the  (**Contacts**) key.
2. (Optional) Tap the search bar, enter the first letters of the contact's name, and tap the blue return button to initialize the search function.
3. Tap contact you want to edit.

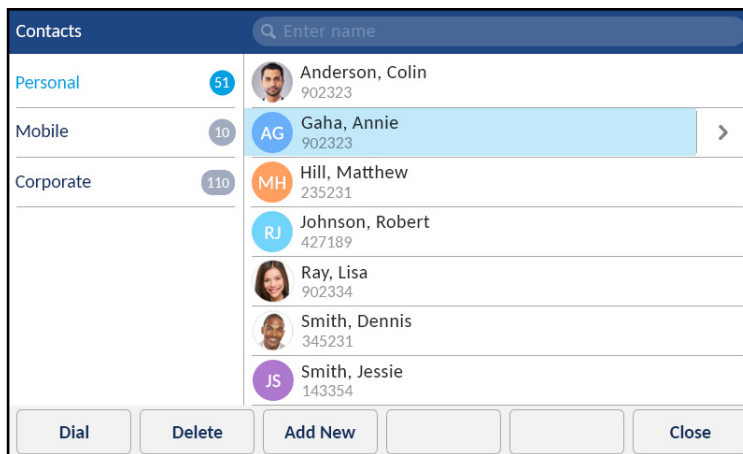

4. Press the right arrow button to view the contact card for the selected contact and tap the **Edit** softkey.

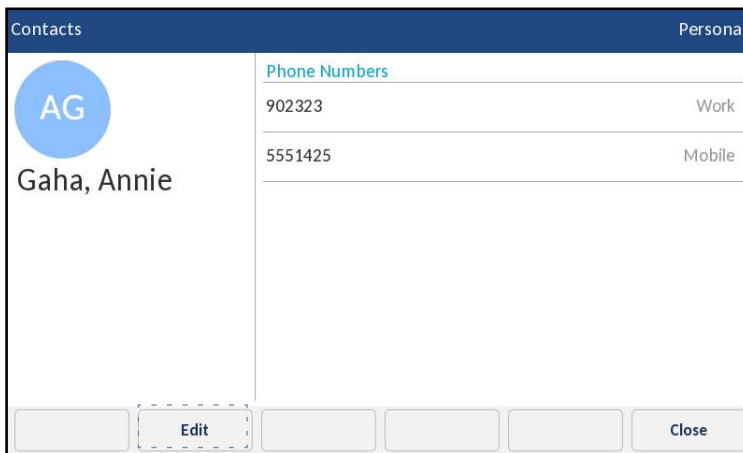

5. Tap to select the information you want change and edit using the on-screen keyboard and dialpad keys.
6. Tap the **Save** softkey to save your changes.

Deleting all contacts from the Personal folder

1. Press the  (**Contacts**) key.
2. Tap the **Delete** softkey.

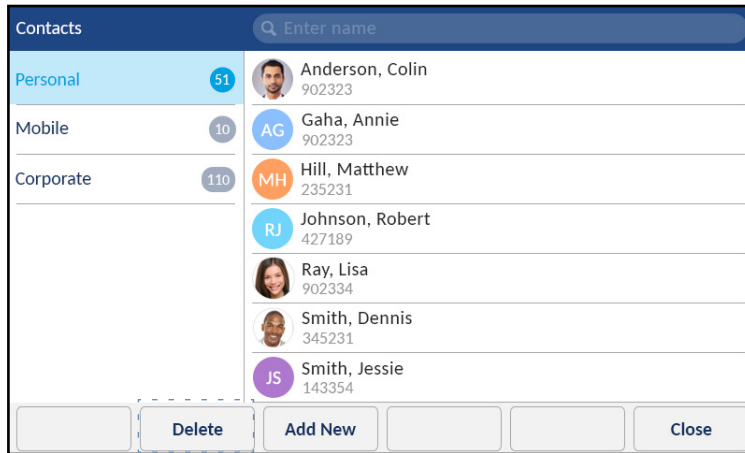

A delete all confirmation message appears on screen.

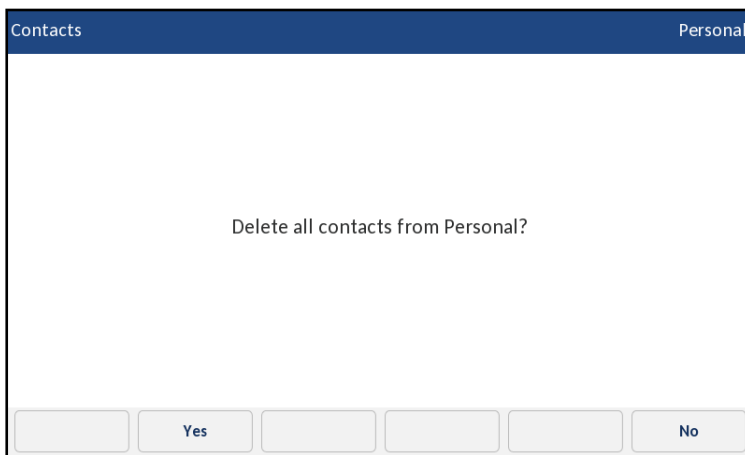

3. Tap the **Yes** softkey to delete all contacts from your **Personal** folder.

Note: Tap the **No** softkey to cancel the delete process.

Deleting a contact from the Personal folder

To delete contacts from your **Personal** folder:

1. Press the  (**Contacts**) key.
2. (Optional) Tap the search bar, enter the first letters of the contact's name, and tap the blue return button to initialize the search function.
3. Tap to select the applicable contact and tap the **Delete** softkey.

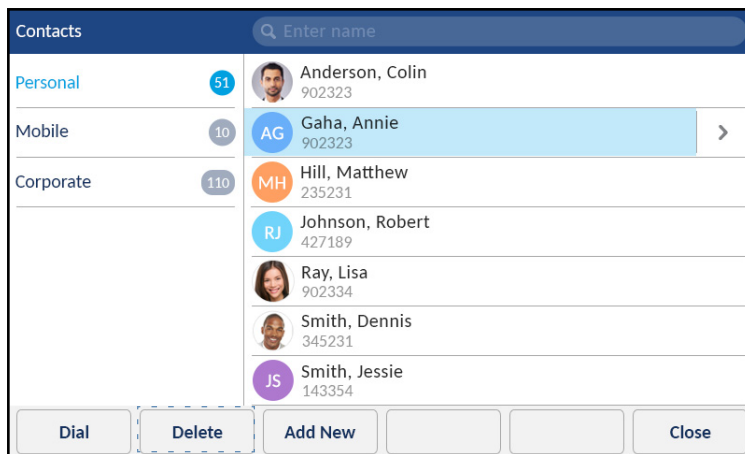

A delete confirmation message appears on screen.

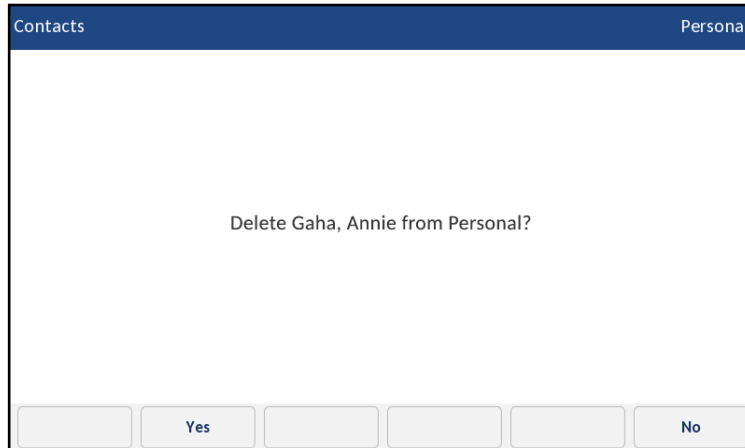

4. Tap the **Yes** softkey to delete the selected contact from your **Personal** folder.

Note: Tap the **No** softkey to cancel the delete process.

Corporate and Mobile folder features

The **Corporate** folder contains the contacts that are available through your corporate LDAP directory. The **Mobile** folder contains your mobile phone contacts (if synchronized).

Notes:

1. Access to corporate directories must be set up by your System Administrator.
2. Updates made to your corporate directory are reflected on your phone only at the re-synchronization time configured on the MiVoice Business phone system.
3. For more information on syncing mobile contacts and MobileLink functionality, see [“Syncing mobile contacts”](#) on page 89.

There are two types of corporate directories that can be configured:

1. **Cached:**

Contacts are cached on the phone and are viewable as a list in the **Corporate** contact folder upon entering the Contacts application. You can scroll up and down to view your list of corporate contacts. Performing a basic search applies to both the **Personal** and **Corporate** contacts folders.

2. **Non-cached:**

Contacts are not cached on the phone and therefore contacts are not available until you perform a lookup in the **Corporate** contact folder. Used for corporate directories with a large amount of contacts as caching a large amount of contacts could, at times, overload the IP phone.

You can perform all the same functions as the **Personal** folder from the **Corporate** and **Mobile** folders except for adding, deleting, and editing entries. In addition to being able to search for a corporate or mobile contact, place a call to the selected corporate or mobile contact, and view corporate or mobile contact's contact card, you can copy the corporate or mobile contact to your **Personal** folder.

Note: See [“Performing a search”](#) on page 68 for details on how to perform a search on your cached **Corporate** contact folder as well as your **Mobile** contact folder.

Performing a search on a non-cached Corporate contact folder

To perform a search on a non-cached **Corporate** contact folder:

1. Press the  (**Contacts**) key.

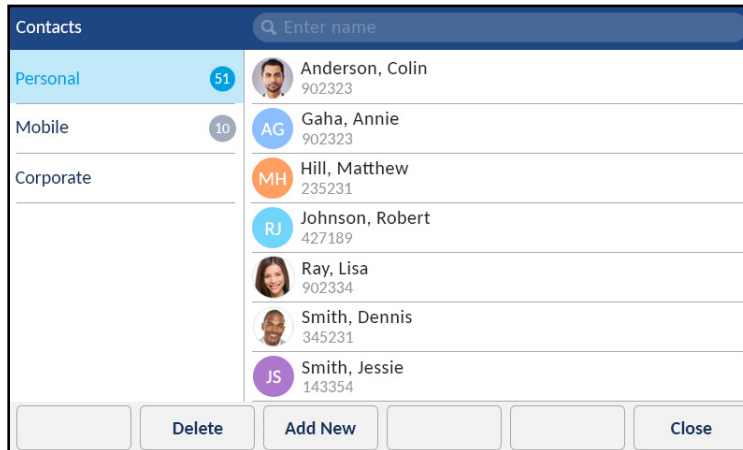

2. Tap the **Corporate** folder.

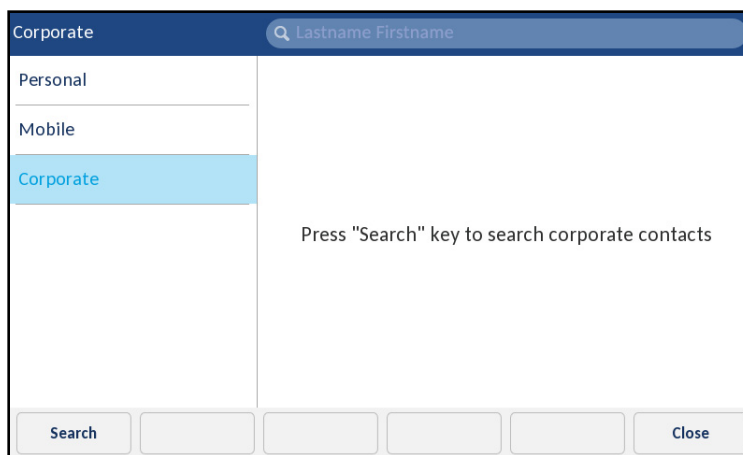

3. Tap the **Search** softkey or search bar.

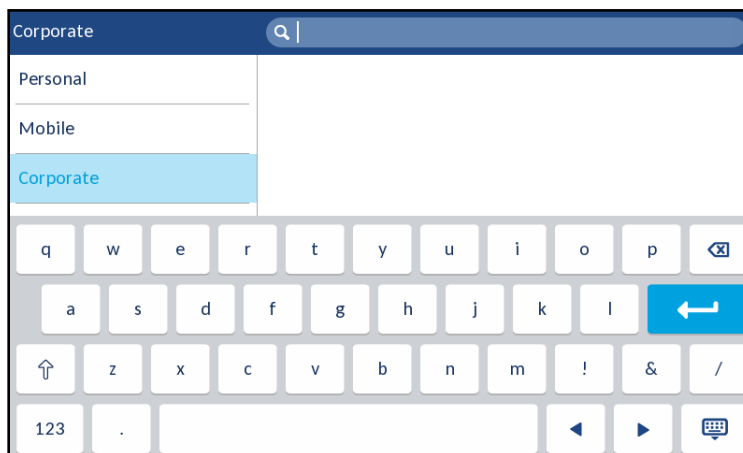

- Using the on-screen keyboard enter in the first letters of the contact's last name and tap the blue return key.

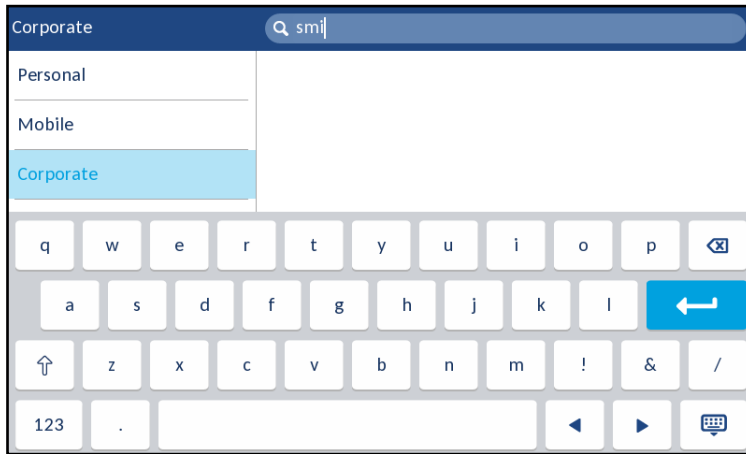

Note: For non-cached corporate directories, searches are based on the last name of the contact.

- If matches are found, tap the applicable contact entry and perform your desired action.

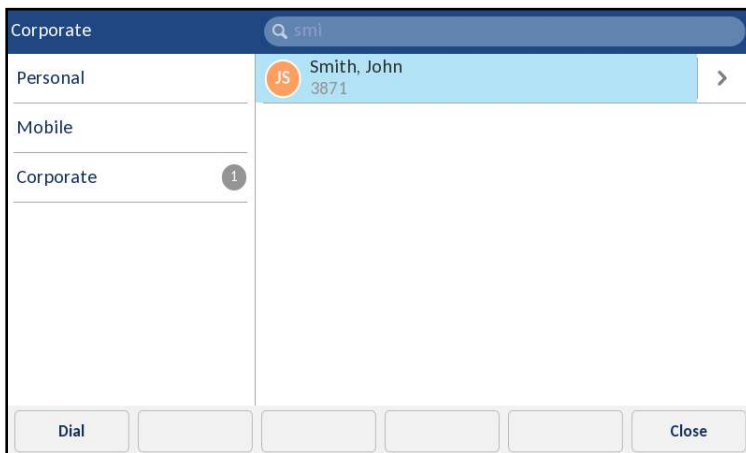

Copying a Corporate or Mobile contact to the Personal folder

To copy a contact in your **Corporate** or **Mobile** folder to your **Personal** folder:

- Press the  (**Contacts**) key.
- If applicable, for non-cached corporate directories, perform a search as detailed in [“Performing a search on a non-cached Corporate contact folder”](#) on [page 77](#)
or
(Optional) For cached corporate directories, tap the search bar, enter the first letters of the contact's name, and tap the blue return button to initialize the search function.

3. Tap to select the corporate or mobile contact you want to copy to your **Personal** folder.

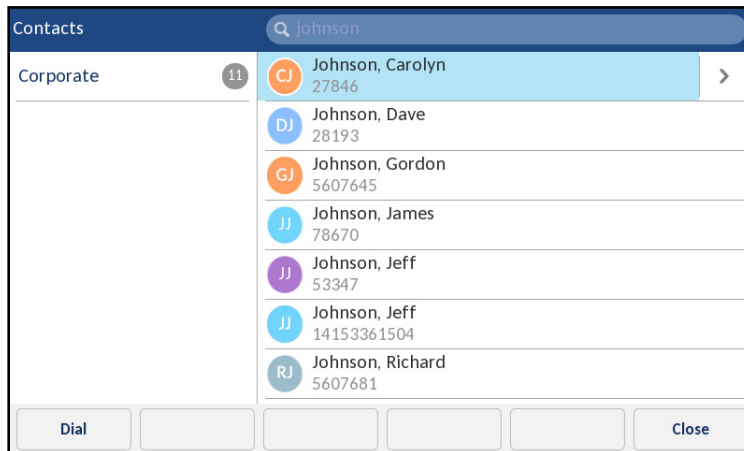

4. Tap the right arrow button to view the corporate or mobile contact's contact card.

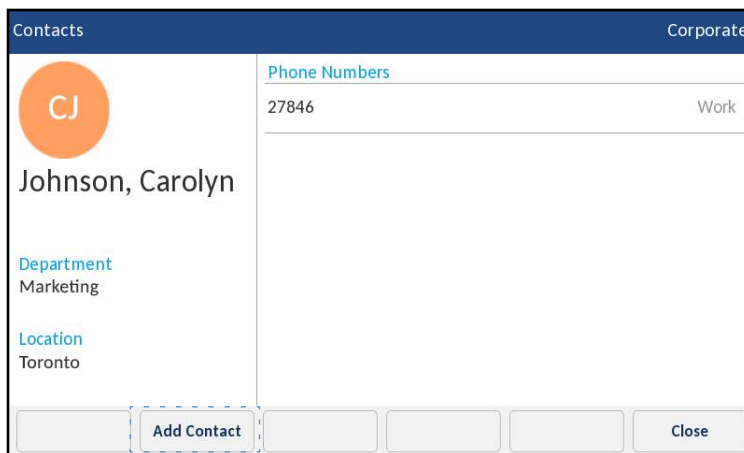

5. Tap the **Add Contact** softkey.
A copy confirmation message is displayed.



Call History

The **Call History** application is a stored log of all your calls. You can view details of all your outgoing and received calls as well as any calls that were unanswered or missed. Your telephone logs the type of call, information regarding the remote party (name, number, and avatar), and the time of the call.

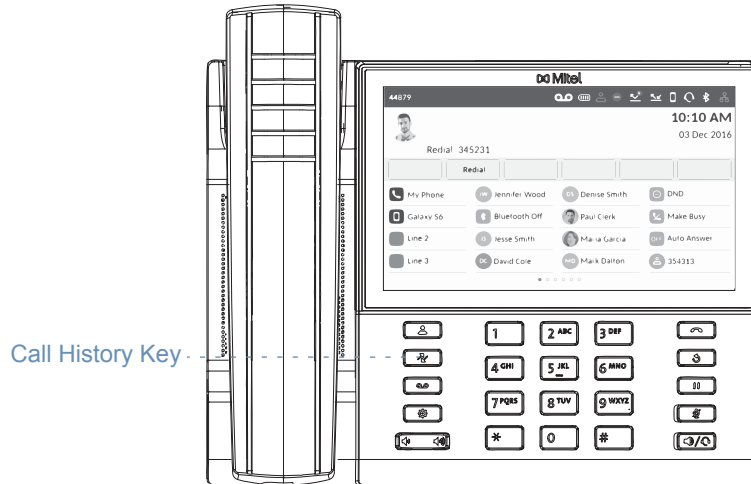
You can view and delete entries in the **Call History** as well as copy selected entries to the your **Personal** folder in the **Contacts** application. You can also dial an entry directly from the **Call History** application.



The following table identifies and describes the various icons displayed in the **Call History** application:

Icon	Description
	Indicates an incoming call that was not answered (missed).
	Indicates an outgoing call (outgoing)
	Indicates an incoming call that was answered (received).

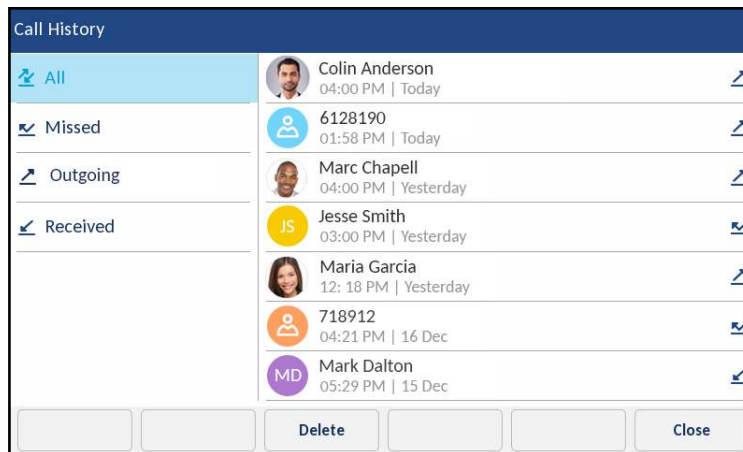

To access and use the **Call History** application:

1. Press the  (**Call History**) key.



2. Type the call type (**All**, **Missed**, **Outgoing**, and **Received**) to view the respective list of call entries.
3. Swipe up and down to scroll through the call entries.
4. Tap to select a call entry.
5. Press the right arrow button beside the selected call entry to display the individual call details.

Note: The call details screen contains the avatar of the caller (if available), the date and time of the call, and the caller ID details.

6. Tap the **Dial** softkey or press the  (**Speaker/Headset**) key for speaker or headset operation or
Pickup the handset for handset operation.
7. Press the  (**Goodbye**) key or tap the **Close** softkey to exit.

Deleting entries from the Call History application

You can delete all entries in the **Call History** application regardless of call type, all entries within a call type folder, or individual entries.

To delete all entries from the **Call History** application:

1. Press the  (**Call History**) key.
2. Tap the **All** call type folder.

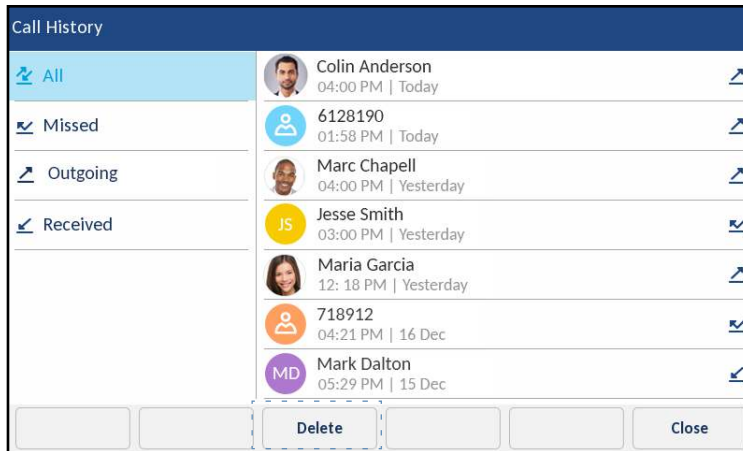

3. Tap the **Delete** softkey.
A delete all confirmation message appears on screen.

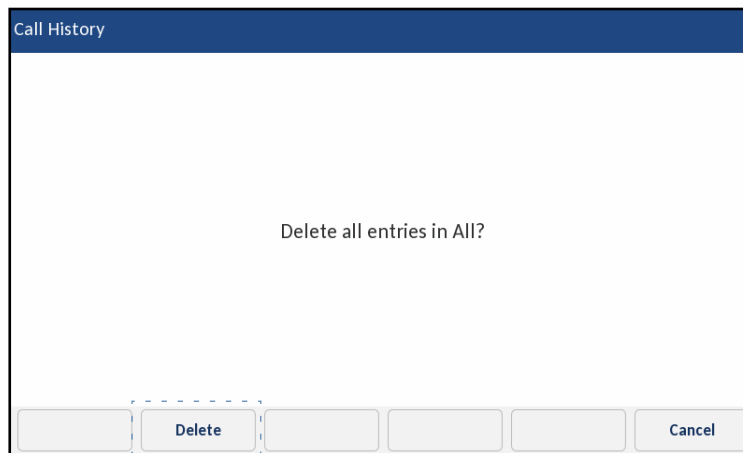

4. Tap the **Delete** softkey again to delete all entries in the **Call History** application.

Note: Tap the **No** softkey to cancel the delete process.

To delete all entries from a call type folder:

1. Press the  (**Call History**) key.
2. Tap the applicable call type folder you wish to delete.

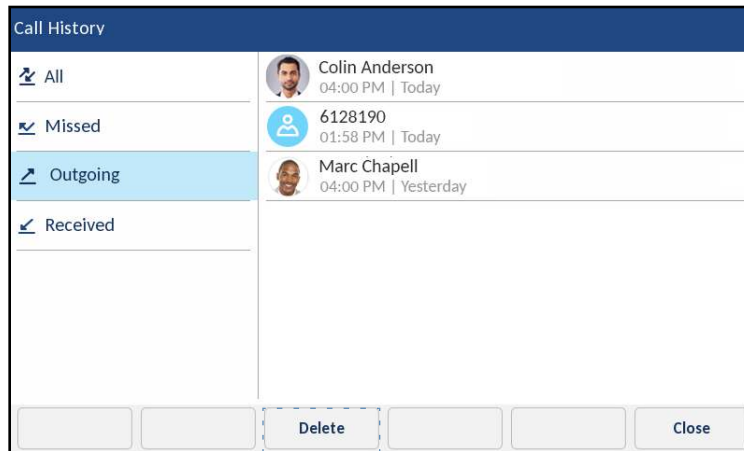

3. Tap the **Delete** softkey.
A delete all confirmation message appears on screen.

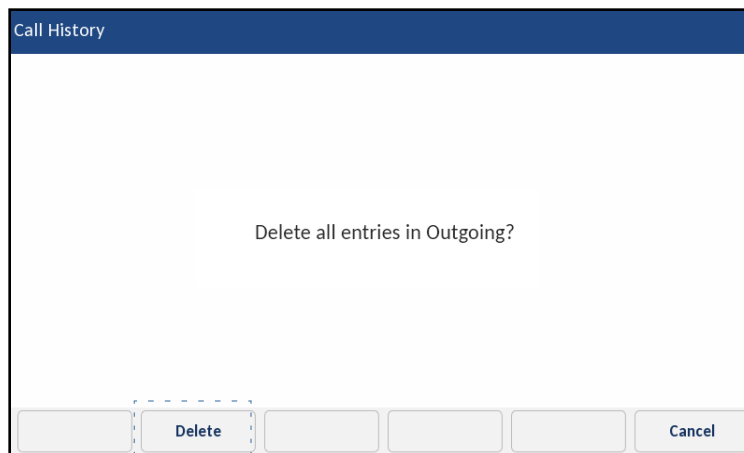

4. Tap the **Delete** softkey again to delete all entries in the selected call type folder.

Note: Tap the **No** softkey to cancel the delete process.

To delete individual entries from a call type folder:

1. Press the  (**Call History**) key.
2. Tap the applicable call type folder.
3. Tap to select the individual call entry.

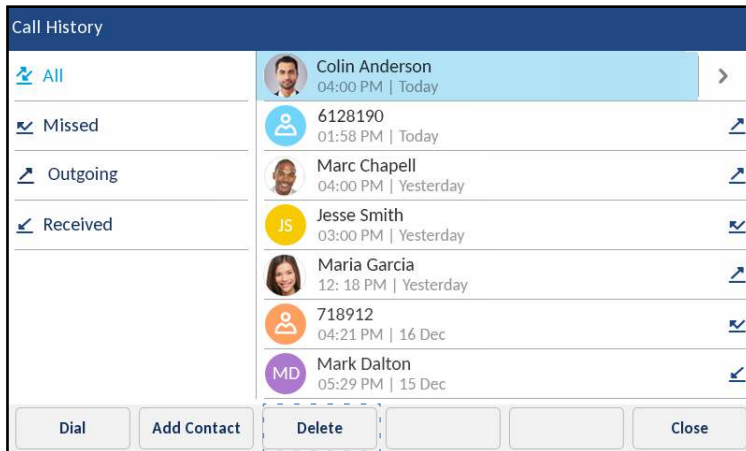

4. Tap the **Delete** softkey.
A delete confirmation message appears on screen.

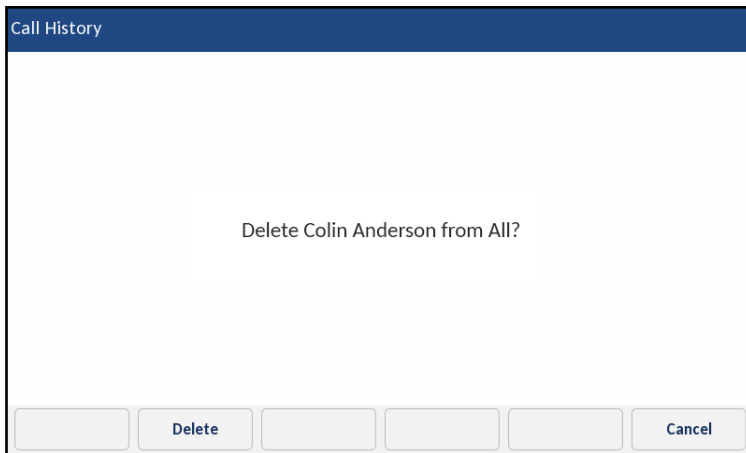

5. Tap the **Delete** softkey again to delete the individual call entry.

Note: Tap the **No** softkey to cancel the delete process.

Copying entries to the Personal folder in the Contacts application

To copy a Call History entry to the **Personal** folder in the **Contacts** application:

1. Press the  (**Call History**) key.
2. Tap the applicable call type folder.
3. Tap to select the call entry you want to copy to your **Personal** folder in your **Contacts** application.

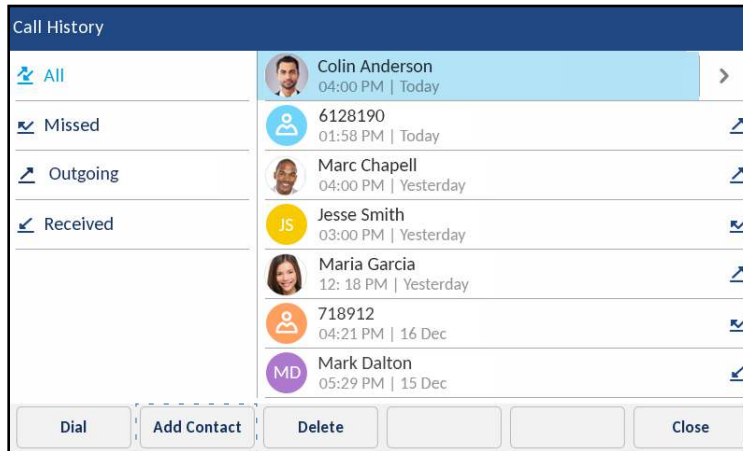

4. Tap the **Add Contact** softkey.
A copy confirmation message is displayed.

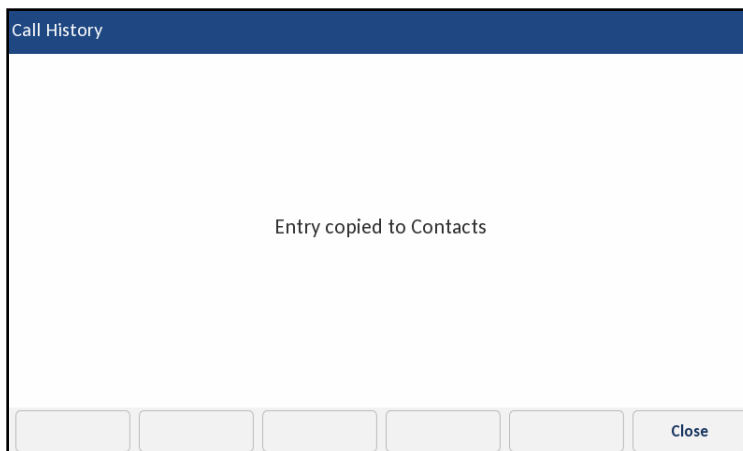

Missed calls indicator

The Mitel MiVoice 6940 IP phone has a missed calls icon located on the status bar that indicates the number of calls that went unanswered.

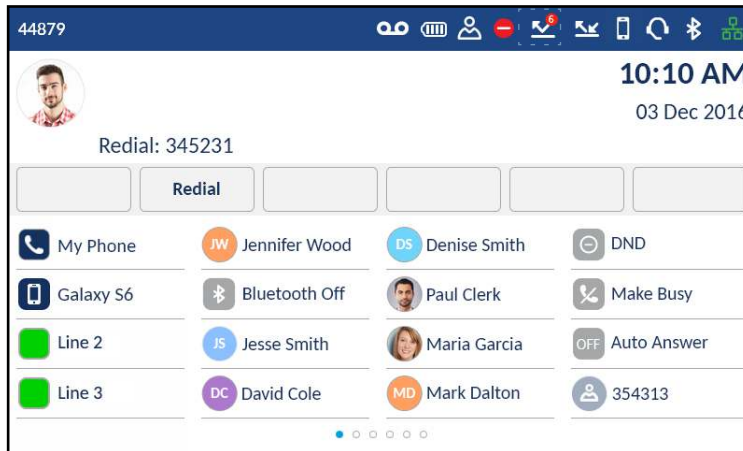



As the number of unanswered calls increment, the information associated with the calls are stored in the **Call History** application under the **Missed** call folder. When the user accesses the **Missed** call folder, the missed call indicator on the **Home** screen is removed.

Note: Missed calls are also indicated on the screensaver.

To view missed call details in Call History application:

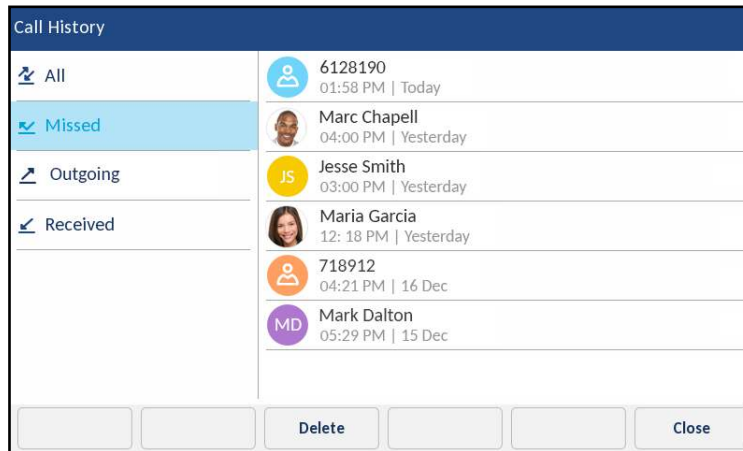
1. Press the  (**Call History**) key.
2. Tap the **Missed** call type folder.



3. Tap the individual call entry.
4. Tap the right arrow button to see more detailed information about the call entry.
5. Press the  (**Goodbye**) key or tap the **Close** softkey to exit. The missed calls indicator on the **Home** screen is cleared upon exit.

Voicemail

Note: Voicemail functionality must be configured by your System Administrator.

When voicemail functionality is enabled, the MWI LED on the Mitel MiVoice 6940 flashes red and the  (Voicemail) icon displays on the status bar indicating that voicemail messages are available. You can access your voicemail service by pressing the **Voicemail** key.

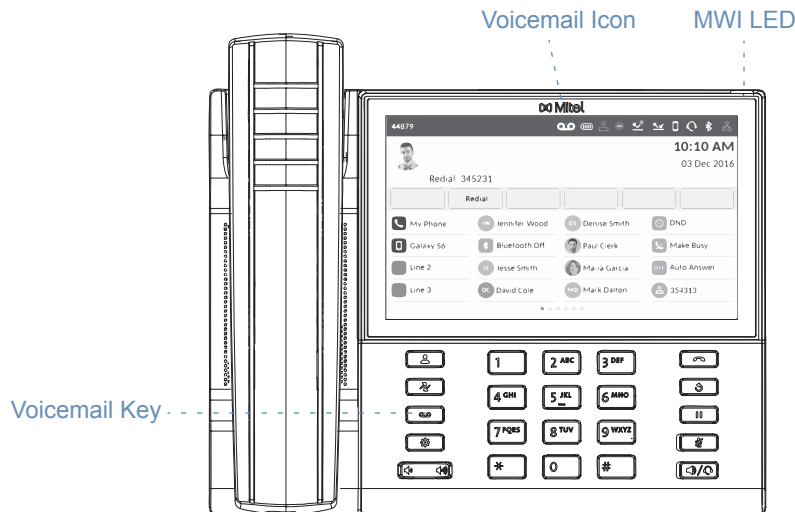

To access your voicemail:

1. Press the  (**Voicemail**) key.

Notes:

1. If the handset is offhook or if the phone is in speakerphone or headset mode, pressing the  (**Voicemail**) key will call your message center directly.
2. The call to your message center is placed regardless of whether or not a message is pending.
2. (Optional) If your phone is idle, tap the **More** softkey to view the date and time of the last voicemail message received.

Note: Tapping the **Erase** key clears the current message indicators on the phone (i.e. MWI LED and last voicemail message received history). It does not delete the messages contained in your voicemail account.

3. If your phone is idle, tap the **Call** softkey.
4. When you are connected to your message center, follow the audio prompts to perform any applicable actions.

Note: For more detailed information on voicemail features and functionality, see the *Mitel MiVoice Business Voice Mail User Guide*.

MobileLink

The Mitel MiVoice 6940 IP Phone supports MobileLink, a feature that provides seamless mobile integration using Bluetooth wireless technology. MobileLink highlights include the ability to:

- Sync your mobile phone's contact list with your Mitel MiVoice 6940 IP phone.
- Answer a mobile phone call using your Mitel MiVoice 6940 IP phone.
- Move mobile call audio between the Mitel MiVoice 6940 IP phone and your mobile phone.

MobileLink features are available only if your System Administrator has enabled them (a Mobile Line key must be programmed on your phone). Contact your System Administrator for details on how to enable MobileLink functionality on your phone.

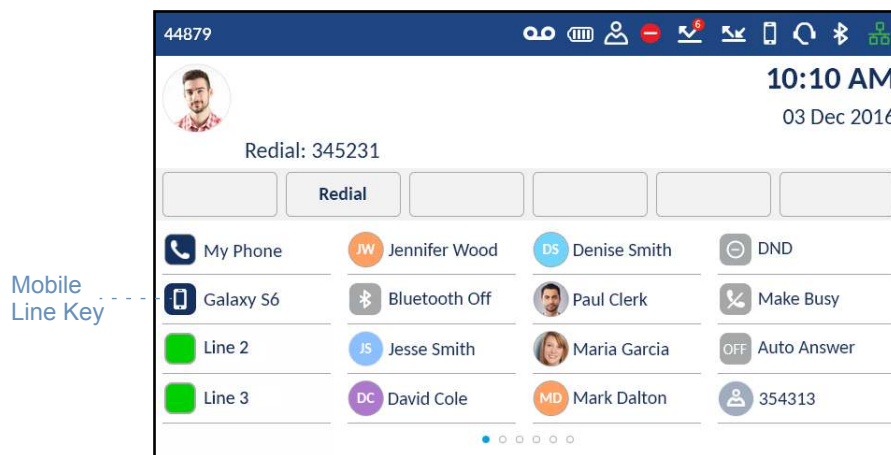

The **Mobile Line** key icon changes to reflect the status of the line as per the following table.

Icon	Description
	Indicates the mobile line is connected with a mobile phone and is idle.
	(Blinking) Indicates the mobile line is ringing due to an incoming call on your mobile phone.
	Indicates the mobile line is busy.
	(Blinking) Indicates an ongoing call with active audio on the mobile phone.
	(Blinking) Indicates the call on the mobile line is on hold.
	(Blinking) Indicates the mobile phone is not connected.

Note: Additional Bluetooth devices connected to your mobile phone (e.g. smartwatches, headsets, etc...) may impede or alter the behavior of the MobileLink feature. It is recommended to disconnect any additional Bluetooth devices from your mobile phone when using the MobileLink feature on your Mitel MiVoice 6940 IP Phone.

Pairing a mobile phone using Bluetooth

For instructions on how to pair your mobile phone with your Mitel MiVoice 6940 IP phone, see “Pairing a Bluetooth device” on page 32.

Syncing mobile contacts

When pairing and connecting a mobile phone for the first time, the Mitel MiVoice 6940 IP phone automatically attempts to sync your mobile contacts to the **Contacts** application.

Note: Your initial mobile contact list will remain in the **Contacts** application even if you connect to a secondary mobile phone. To update your mobile contacts so that they are aligned with the secondary mobile phone, you must manually synchronize your mobile contacts.

To manually update your mobile clients:

1. Ensure you
2. Press the  (**Contacts**) key.

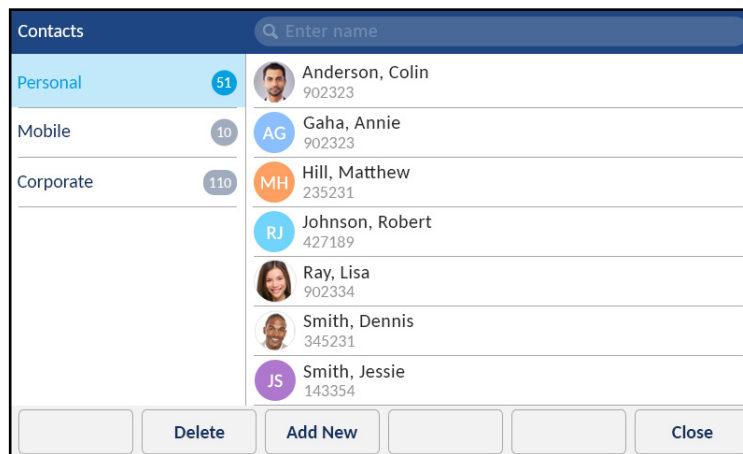

3. Tap the **Mobile** contacts folder.

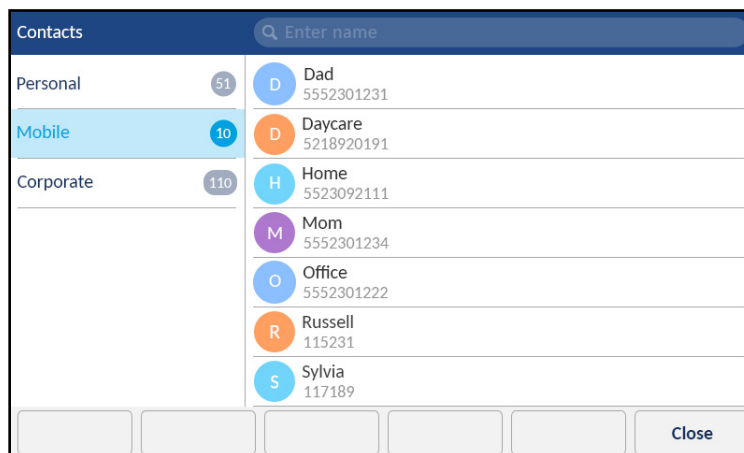

4. Tap the **Update** softkey.
The Mitel MiVoice 6940 IP phone attempts to re-synchronize and update your mobile contacts.



Notes:

1. You may need to acknowledge the request on your mobile phone.
2. If the update fails, a failed to retrieve contacts message displays on screen. Tap **Retry** to attempt to update again, or **Cancel** to cancel the attempt.
3. Some mobile phones will only sync contacts stored on the phone's flash memory. Contacts stored on the phone's SIM card may not sync with the Mitel MiVoice 6940 IP phone.
4. Mobile contacts are cleared from the **Contacts** application when the phone's firmware has been upgraded. If your mobile device is configured to allow for automatic re-synchronization, the Mitel MiVoice 6940 IP phone will synchronize the contacts again the next time your mobile device connects to your IP phone. If your mobile device is not configured for automatic re-synchronization, you must manually synchronize your mobile contacts.
5. For more information on the **Contacts** application, see "[Contacts](#)" on page 66.

Answering an incoming mobile call using your Mitel MiVoice 6940 IP phone

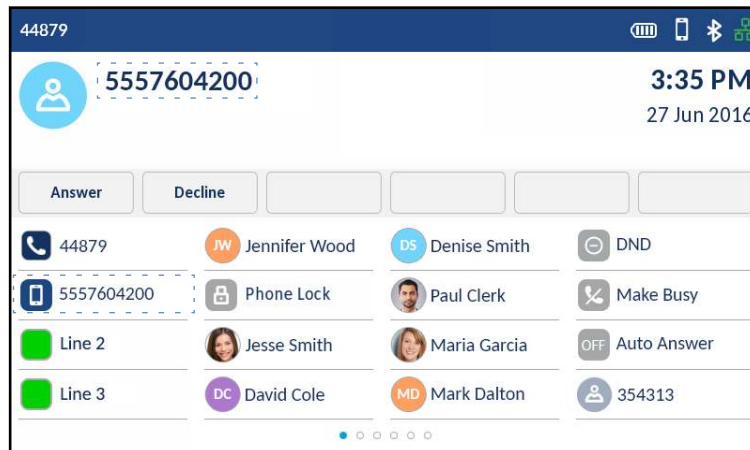
When your mobile phone is paired and connected to your Mitel MiVoice 6940 IP phone, incoming calls on your mobile phone will be indicated on your Mitel MiVoice 6940 IP phone as well.



To answer the incoming mobile call using your Mitel MiVoice 6940 IP phone, lift the handset for handset operation, or press the  (**Speaker/Headset**) key, tap the blinking  **Bluetooth Line** key, or tap the **Answer** softkey for handsfree operation.

Note: Tap the **Decline** key to reject the incoming mobile phone call.

Moving audio from an active mobile call between your mobile phone and Mitel MiVoice 6940 IP phone

Switching mobile phone audio from your Mitel MiVoice 6940 IP phone to your mobile phone and back again is performed by a one-key-tap method.

Tap the **Push call** softkey to push the mobile call audio from your Mitel MiVoice 6940 IP Phone to your mobile phone.

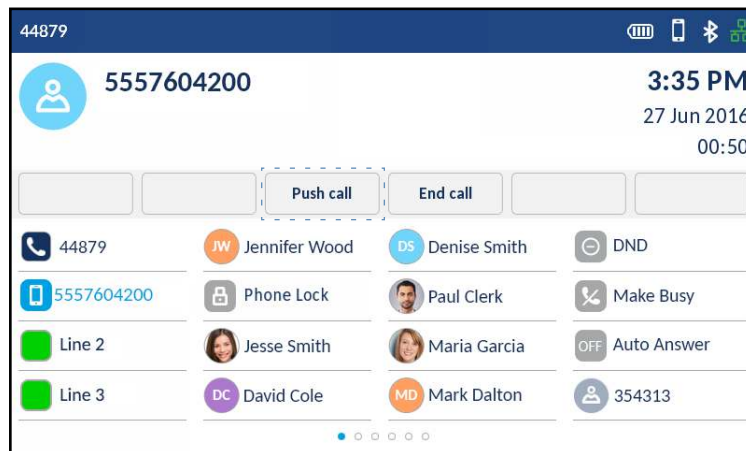

Tap the **Mobile Line** key to push the mobile call audio from your mobile phone to the Mitel MiVoice 6940 IP Phone.

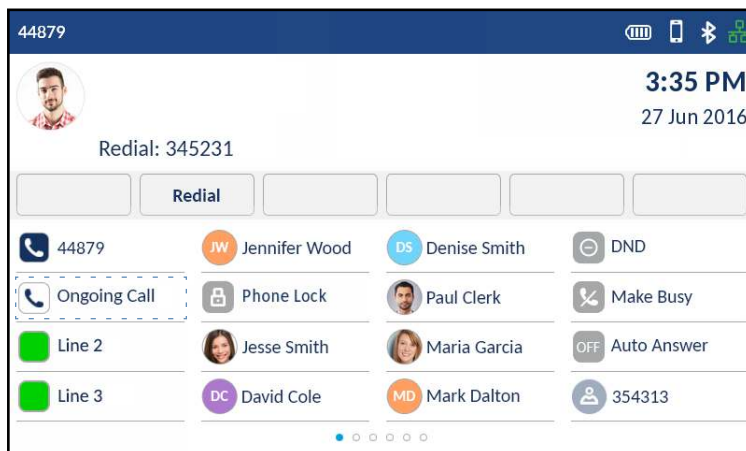

























Additional features











The following features are available using feature keys only if your System Administrator has defined a programmable key or softkey with the respective functionality on your phone.















When configured on a programmable key, icons are displayed beside the label indicating type of functionality. When a generic ON/OFF icon or a custom ON/OFF icon (such as those displayed for DND, Make Busy, Phone Lock, Call Fwd Always, Night Service, and Record a Call) is displayed, the key acts as a toggle to enable and disable the respective feature. If no icons displayed beside the key's label, the feature either requires user input or is used to convey information.



For detailed information on how to use any of the following features, please contact your System Administrator.

Feature	Description	Icons	Type
Account Code NonVerified	Non-verified Account Codes let you enter codes on the SMDR record for billing and/or call management.		Non-Toggle
Account Code Verified	Verified Account Codes let you access features that are not normally available at a station. You enter Verified Account Codes before making a call to change the COS and COR at any station. When you hang up, the station returns to normal.		Non-Toggle
ACD	Automatic Call Distribution (ACD) functionality allows call centers to process incoming calls based on a number of customizable parameters.		Non-Toggle
Auto Answer	Auto-Answer lets you automatically answer calls that ring your Prime line.		Toggle ON/OFF
Call Fwd Always	Call Fwd Always is used to redirect all incoming calls to an alternate number.		Toggle ON/OFF
Call Fwd Busy	Call Fwd Busy is used to redirect both incoming internal and external calls to an alternate number when your phone is busy.		Toggle ON/OFF
Call Fwd Busy External	Call Fwd Busy is used to redirect incoming external calls to an alternate number when your phone is busy.		Toggle ON/OFF
Call Fwd Busy Internal	Call Fwd Busy is used to redirect incoming internal calls to an alternate number when your phone is busy.		Toggle ON/OFF
Call Fwd No Ans. External	Call Fwd No Ans. External is used to redirect incoming external calls to an alternate number when you do not answer.		Toggle ON/OFF
Call Fwd No Ans. Internal	Call Fwd No Ans. Internal is used to redirect incoming internal calls to an alternate number when you do not answer.		Toggle ON/OFF

Feature	Description	Icons	Type
Call Fwd No Answer	Call Fwd Busy is used to redirect both incoming internal and external calls to an alternate number when you do not answer.	 	Toggle ON/OFF
Call Park and Call Park - Retrieve	Call Park allows you to place a call in a special hold state. You, or someone else, can then retrieve the call from another extension in the system by pressing the Call Park - Retrieve key.	 	Toggle ON/OFF
Call Pickup	Call Pickup lets you answer a call that is ringing at another station, including an attendant console.	 	Toggle ON/OFF
CDE Speedcall	This feature allows you to speed dial telephone numbers that the administrator has programmed into the system.	Avatar	Non-Toggle
Direct Page	Direct Page allows you to page another telephone over its built-in speaker, even if the telephone is in use.	 	Toggle ON/OFF
Do Not Disturb	Do Not Disturb (DND) stops internal calls from ringing on your phone and returns busy tone to the caller. DND does not stop external calls from ringing nor does it affect your ability to make calls.	 	Toggle ON/OFF
DSS/Busy Lamp	You can use the Busy Lamp Field feature to monitor the status of single-line sets, single-member lines, key system lines, multicall Broadcast Groups, and Hot Desk users.	Line States	Non-Toggle
Emergency Call	The Emergency Call Notification key allows you receive emergency call notifications. Pressing the key allows you to view the caller's directory number, special instructions that are programmed for the DN in the Comments field of the CESID Assignment form, and the date and time of the call.	 	Toggle ON/OFF
Group Listen	With Group Listen, you can carry on a conversation using the handset or headset while allowing others nearby to listen to the person at the far end over the handsfree speaker.	 	Toggle ON/OFF

Feature	Description	Icons	Type
Group Park	Group Park allows you to place a call in a special hold state. You, or someone else, can then retrieve the call from another extension in the system. Group Park uses a single feature key to both park and retrieve calls. Any telephone programmed with the same Group Park key can retrieve the call.	 	Toggle ON/OFF
Group Presence	Group Presence allows members of call groups (Hunt, ACD, Ring, Personal Ring, and Multi-device User) to make themselves absent or present in a group. Only members who are present in a group are offered calls to that group.	 	Toggle ON/OFF
Handoff	The Handoff feature for Personal Ring Groups (PRGs) allows calls to be "Pushed" or "Pulled" between group member devices. A Push passes the call to the group, where it can be answered by any other present group device. A Pull takes an in-progress call away from another member.	 	Toggle ON/OFF
Key System	Key System Groups let multiple telephones share the same extension number. Incoming calls ring all of the idle stations, and the stations stop ringing when one member answers the call. Only one member of a Key System Group can use the line at one time.	Line States	Non-Toggle
Make Busy	The Make Busy feature ensures an ACD extension does not receive ACD calls when the agent is unavailable. The ACD extension remains in the Make Busy state until an agent deactivates it.	 	Toggle ON/OFF
Meet Me Answer	Meet-Me Answer lets you respond to a Group Page that you missed, even if you do not know the identity or location of the person that paged you.		Non-Toggle
Message Waiting Indication	Keys can be programmed as message waiting indicators which are associated with the mailboxes of other stations. The indicator flashes when a message is waiting in the associated mailbox. This allows you to look at the phone and recognize which mailboxes have messages.	 	Toggle ON/OFF

Feature	Description	Icons	Type
Multicall	Multicall Groups let multiple telephones share the same extension number. Incoming calls ring all of the idle stations, and the stations stop ringing when one member answers the call. A Multicall group allows more than one group member to use the line at the same time.	Line States	Non-Toggle
Night Answer	Night Answer lets you send your calls to another location when the system is in Night Service.	 	Toggle ON/OFF
Night Service Indication	Night Service switches the system from day service to night service and vice versa. When the system is placed into night service (usually at the end of the workday) incoming external calls ring at an extension(s) selected by the Administrator.	 	Toggle ON/OFF
Paging	Paging lets you connect to loudspeaker or paging equipment to make an announcement. You can access individual paging zones or all paging zones simultaneously. A one-way connection is established for "All Zones" paging. A two-way connection is established for "Individual Zones" loudspeaker page.	 	Toggle ON/OFF
Personal Presence	Personal Presence lets you choose which of your personal answer points you want to receive your calls at.	 	Toggle ON/OFF
Phone Lock	The Phone Lock feature locks a set, preventing access to the majority of features, with the following exceptions: unlocking the set via a user PIN, Hot Desk Login and Logout support, and Emergency Call Notification support. Phone Lock has no effect on incoming calls but restricts outgoing calls, with the following exceptions: calls to emergency trunk routes and local operators.	 	Toggle ON/OFF
Privacy Release	Privacy Release allows members of a Key System Group to disable automatic call privacy protection to allow another member of the group to join the call. When a new member enters the call the original members receive a conference tone and the privacy feature is restored.	 	Toggle ON/OFF
Record a Call	Record-a-Call (RAC) allows extension users to record a two-party call when one party is connected to a trunk. The recorded conversation is stored in the users' voice mail mailbox.	  	Toggle ON/OFF (and Pause)

Feature	Description	Icons	Type
Secretarial	A DSS key provisioned with the "secretarial" option allows you to perform a transfer to the associated device or directory number.	Line States	Non-Toggle
Single Line	The Single Line feature is used to set the prime line as a single line, whereby it is dedicated to one phone only.	Line States	Non-Toggle
Specific Group Alert	A Specific Group Alert key normally appears only on an ACD supervisor's telephone. Each Specific Group Alert key allows the supervisor to obtain queue status information for a specific agent skill group. A supervisor's telephone may have several Specific Group Alert keys.		Non-Toggle
Superkey	Superkey programming allows for easy access to telephone system features and feature-set customization.		Non-Toggle
Tag Call	Tag Call allows phone users to signal that they are the victim of a malicious call. This Malicious Call Indication is logged as an SMDR record.		Non-Toggle
User Speedcall	User Speedcall keys allow you to store external numbers under feature keys for faster dialing. You can press a Speed Call Key to dial a phone number or, during a call, to outpulse DTMF tones.	Avatar	Non-Toggle
User Speedcall - Private	A private User Speedcall is a User Speedcall that is considered private, whereby Caller ID information is not displayed in the phone's call history.	Avatar	Non-Toggle

Accessory support

Mitel M695 Programmable Key Module (PKM)

Up to three Mitel M695 PKMs can be attached to the right of the Mitel MiVoice 6940 IP phone providing you with 84 additional programmable keys (28 keys per PKM).

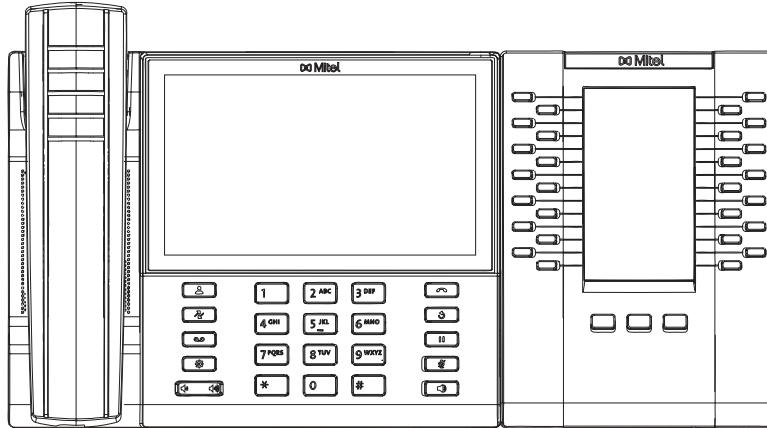

The Mitel M695 PKM features a 4.3" 480x272 pixel color backlit LCD display that provides a unified graphical user experience with the Mitel MiVoice 6940 IP phone.

The Mitel M695 PKM supports the same programmable key functions as the Mitel MiVoice 6940 IP phone. The programmable keys can only be programmed by your System Administrator.

Notes:

1. For the Mitel MiVoice 6940 IP phone, the USB port on the phone will be disabled () if the phone is being powered using 802.3af PoE and two or more expansion modules are connected. Use a Mitel approved power adapter or power the Mitel MiVoice 6940 IP phone using 802.3at PoE plus to ensure the USB port will be functional when two or more expansion modules are connected.
2. For information how to install your Mitel M695 PKM, see the *Mitel M695 PKM Installation Guide*.

Mitel Wireless LAN Adapter

The Mitel Wireless LAN Adapter is a wireless bridge that can add wireless connectivity functionality to your Mitel MiVoice 6940 IP phone. It allows your Ethernet-enabled phone to join a secure, high-speed network. It is software transparent meaning no changes to drivers, management tools, or applications are needed.

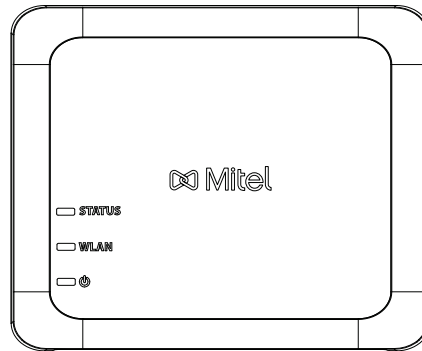

Feature highlights include:

- **Easily add robust, secure wireless capabilities to Ethernet devices:**
The Mitel Wireless LAN Adapter is a high-performance wireless network adapter which enables any Ethernet device to become an 802.11a/b/g/n dual band wireless network device, giving you freedom to place it anywhere in your facility.
- **Dual band IEEE 802.11a/b/g/n support:**
The Mitel Wireless LAN Adapter is designed to communicate in the 2.4 GHz and 5 GHz bands. Radio interference in the commonly used 2.4 GHz band can be avoided by utilizing 5 GHz.
- **Gigabit Ethernet support:**
The wired LAN port supports 10/100/1000BASE-T (auto-recognition).
- **Simple to setup and use:**
The Mitel Wireless LAN Adapter is easy to set up using the enclosed network setup cable. No special drivers or software are required.
- **Enterprise security:**
The Mitel Wireless LAN Adapter supports the following security functions:
 - WEP (64 Bit/128 Bit)
 - WPA-PSK (TKIP/AES)
 - WPA2-PSK (AES)
 - IEEE 802.1X EAP-PEAP, EAP-TLS, EAP-TTLS, EAP-FAST, EAP-LEAP

Note: For information how to install and set up your Mitel Wireless LAN Adapter, see the *Mitel Wireless LAN Adapter Setup Guide*

Mitel cordless Bluetooth handset

The Mitel MiVoice 6940 IP phone provides support for the optional Mitel cordless Bluetooth handset. With a potential range of up to 10 meters (30 feet), the Bluetooth handset offers convenience and corridor mobility for Mitel MiVoice 6940 IP phone users.

Feature highlights include:

- Hookswitch (Initiate call/end call) key
- Volume control keys
- Mute key
- Built-in handset ringer
- LED indicators to indicate both connectivity and charging status
- At least six hours talk time
- Over 40 hours standby time
- Handset battery recharge time of three hours or less
- Operating range of up to 30 feet (10 meters) from the IP phone
- Wideband audio capable

Notes:

1. To pair the handset with the Mitel MiVoice 6940 IP phone, power on the handset and follow the procedures detailed in [“Pairing a Bluetooth device”](#) on [page 32](#). The device name will appear in the available devices list as "Cordless Handset" followed by the last six digits of the handset's MAC address.
2. For information how to set up your Bluetooth handset, see the *Mitel Cordless Bluetooth Handset Installation Guide*.

Hardware features

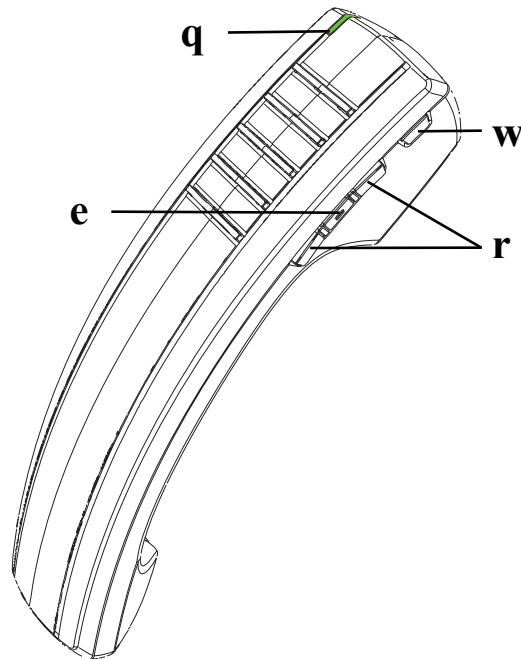

Number	Feature	Description
q	LED	Blue - Indicates the status of the handset. Green - Indicates the status of the handset battery. For more information, see “LED indicator” on page 16.
w	Hookswitch key	Lifting the handset from the cradle activates the handset. If the handset is already out of the cradle, pressing the Hookswitch key is equivalent to taking the handset off hook. Pressing the key again is equivalent to placing the handset on hook. Pressing the Hookswitch key while on a speakerphone call moves the call to the cordless handset.
e	Mute key	Mutes the handset microphone so that your caller cannot hear you. For more information, see “Muting the microphone” on page 61.
r	Volume controls	Adjusts the volume for the handset. Press the key above the Mute key to increase the volume and press the key below the mute key to decrease the volume.

LED indicator

The cordless Bluetooth handset has two LEDs:

- Blue – indicates the operational status of the handset.
- Green – indicates the status of the electrical charge of the battery.

LED color, states, and indicator descriptions are as follows:

LED Color	LED State	Indicates
Blue (Handset Not in Cradle)	Blinking	Handset is not connected and is in pairing mode.
	Winking	Handset is connected but not in use.
	Fading	Handset is connected and in use.
Green (Handset in Cradle)	Solid	Battery is fully charged.
	Winking	Battery is charging. Note: It is normal for the handset LED to cycle between winking and solid as battery charge is maintained.
	Off	When handset is cradled and the LED does not flash or illuminate, this indicates an absence of battery power. During the first 30 – 60 minutes that the light is off, the battery may be trickle charging. If that is the case, the LED will resume normal behavior within that 60 minute period. If the LED remains off for more than 60 minutes, then either the battery is no longer chargeable or there is a problem in the charging circuit.

Notes:

1. Blinking denotes the LED is alternating very quickly between on and off.
2. Winking denotes the LED is alternating between being on for a short period of time and then off for a longer period of time.
3. Fading denotes the LED is alternating between fading in and out.



On-screen battery indicator

The battery level is also indicated on-screen in the status bar.



Icons and descriptions are as follows:

Icon	Description
	Battery is fully charged.
	Battery is two-thirds charged.
	Battery is one-third charged.

Icon	Description
	Warning - low battery (within 20 minutes of battery life left).
	Critical warning - low battery (within 2 minutes of battery life left). Note: To continue with a call when the battery of the handset reaches this level, switch to speakerphone or headset mode and then charge the handset by placing the handset on the cradle.

Alerting tones

The handset provides the following alerting tones:

Event	Tone
Power OFF	Four tones successively decreasing in pitch.
Mute key on handset ON	Two low pitched tones

Powering on/off the Bluetooth cordless handset

To power on the Bluetooth cordless handset place the handset on the IP phone's cradle.

To power off the Bluetooth cordless handset, press the **Hookswitch** key for approximately six seconds until the LED indicator turns blue and then turns completely off.

Analog, DHSG/EHS, and USB headsets

The Mitel MiVoice 6940 IP phone accepts USB headsets through the USB port on the back of the phone.

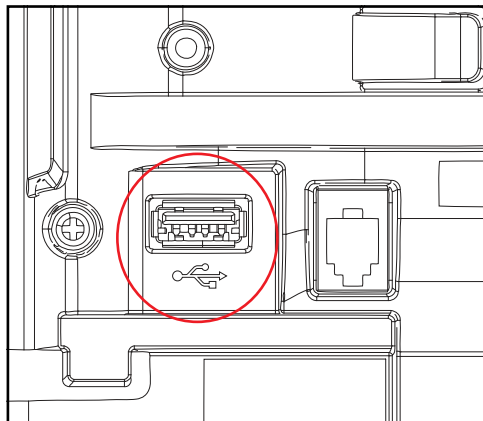

Contact your telephone equipment retailer or distributor to purchase a compatible headset.

Notes:

1. Customers should read and observe all safety recommendations contained in headset operating guides when using any headset.
2. Contact your System Administrator for questions regarding supported headsets or refer to the *MiVoice Business Release 8.0 Release Notes*.
3. Headsets connected to the Mitel MiVoice 6940 IP phone are limited in functionality to answering, ending, and muting calls. Additional headset features (such as rejecting calls) are not supported and will cause unexpected behavior (e.g. invoking the reject call function will answer instead of reject).
4. If both a USB headset and a Bluetooth headset are connected to the phone the Bluetooth headset will take precedence over the USB headset.

To make and receive calls using a headset:

1. Ensure that you have selected the **Headset** audio path (see “[Audio Path](#)” on [page 41](#)).
2. Turn the phone over and, depending on the type of headset, locate the headset jack marked f or the USB port.
3. Insert the headset’s USB plug into the USB port.

Note: See the *Mitel MiVoice 6940 IP Phone Installation Guide* for more information.

Limited warranty

Mitel warrants this product against defects and malfunctions in accordance with Mitel's authorized, written functional specification relating to such products during a one (1) year period from the date of original purchase ("Warranty Period"). If there is a defect or malfunction, Mitel shall, at its option, and as the exclusive remedy, either repair or replace the product at no charge, if returned within the Warranty Period. If replacement parts are used in making repairs, these parts may be refurbished, or may contain refurbished materials. If it is necessary to replace the product, it may be replaced with a refurbished product of the same design and color. If it should become necessary to repair or replace a defective or malfunctioning product under this warranty, the provisions of this warranty shall apply to the repaired or replaced product until the expiration of ninety (90) days from the date of pick up, or the date of shipment to you, of the repaired or replacement product, or until the end of the original Warranty Period, whichever is later. Proof of the original purchase date is to be provided with all products returned for warranty repairs.

Exclusions

Mitel does not warrant its products to be compatible with the equipment of any particular telephone company. This warranty does not extend to damage to products resulting from improper installation or operation, alteration, accident, neglect, abuse, misuse, fire or natural causes such as storms or floods, after the product is in your possession. Mitel will not accept liability for any damages and/or long distance charges, which result from unauthorized and/or unlawful use.

Mitel shall not be liable for any incidental or consequential damages, including, but not limited to, loss, damage or expense directly or indirectly arising from the customer's use of or inability to use this product, either separately or in combination with other equipment. This paragraph, however, shall not apply to consequential damages for injury to the person in the case of products used or bought for use primarily for personal, family or household purposes.

This warranty sets forth the entire liability and obligations of Mitel with respect to breach of warranty, and the warranties set forth or limited herein are the sole warranties and are in lieu of all other warranties, expressed or implied, including warranties or fitness for particular purpose and merchantability.

Warranty repair services

Should the product fail during the Warranty Period;

- **In North America**, please call 1-800-574-1611 for further information.
- **Outside North America**, contact your sales representative for return instructions.

You will be responsible for shipping charges, if any. When you return this product for warranty service, you must present proof of purchase.

After warranty service

Mitel offers ongoing repair and support for this product. This service provides repair or replacement of your Mitel product, at Mitel's option, for a fixed charge. You are responsible for all shipping charges. For further information and shipping instructions:

- **In North America**, contact our service information number: 1-800-574-1611.
- **Outside North America**, contact your sales representative.

Note: Repairs to this product may be made only by the manufacturer and its authorized agents, or by others who are legally authorized. This restriction applies during and after the Warranty Period. Unauthorized repair will void the warranty.

