



# Quick Start

## for Hardware Installation: Avaya S8700 Media Server

**Please disregard any references to the S8710 Media Server in this document. The S8700 Media Server is the currently available product. If you need additional information, please contact your Avaya representative or Avaya authorized business partner.**

555-245-703  
Issue 2  
Comcode 700331317  
June 2004

**Copyright 2004, Avaya Inc.  
All Rights Reserved**

## **Notice**

Every effort was made to ensure that the information in this document was complete and accurate at the time of printing. However, information is subject to change.

## **Warranty**

Avaya Inc. provides a limited warranty on this product. Refer to your sales agreement to establish the terms of the limited warranty. In addition, Avaya's standard warranty language as well as information regarding support for this product, while under warranty, is available through the following Web site: <http://www.avaya.com/support>.

## **Preventing Toll Fraud**

"Toll fraud" is the unauthorized use of your telecommunications system by an unauthorized party (for example, a person who is not a corporate employee, agent, subcontractor, or is not working on your company's behalf). Be aware that there may be a risk of toll fraud associated with your system and that, if toll fraud occurs, it can result in substantial additional charges for your telecommunications services.

## **Avaya Fraud Intervention**

If you suspect that you are being victimized by toll fraud and you need technical assistance or support, in the United States and Canada, call the Technical Service Center's Toll Fraud Intervention Hotline at 1-800-643-2353.

## **Disclaimer**

Avaya is not responsible for any modifications, additions or deletions to the original published version of this documentation unless such modifications, additions or deletions were performed by Avaya. Customer and/or End User agree to indemnify and hold harmless Avaya, Avaya's agents, servants and employees against all claims, lawsuits, demands and judgments arising out of, or in connection with, subsequent modifications, additions or deletions to this documentation to the extent made by the Customer or End User.

## **How to Get Help**

For additional support telephone numbers, go to the Avaya support Web site: <http://www.avaya.com/support>. If you are:

- Within the United States, click the *Escalation Management* link. Then click the appropriate link for the type of support you need.
- Outside the United States, click the *Escalation Management* link. Then click the *International Services* link that includes telephone numbers for the international Centers of Excellence.

## **Providing Telecommunications Security**

Telecommunications security (of voice, data, and/or video communications) is the prevention of any type of intrusion to (that is, either unauthorized or malicious access to or use of) your company's telecommunications equipment by some party.

Your company's "telecommunications equipment" includes both this Avaya product and any other voice/data/video equipment that could be accessed via this Avaya product (that is, "networked equipment").

An "outside party" is anyone who is not a corporate employee, agent, subcontractor, or is not working on your company's behalf. Whereas, a "malicious party" is anyone (including someone who may be otherwise authorized) who accesses your telecommunications equipment with either malicious or mischievous intent.

Such intrusions may be either to/through synchronous (time-multiplexed and/or circuit-based) or asynchronous (character-, message-, or packet-based) equipment or interfaces for reasons of:

- Utilization (of capabilities special to the accessed equipment)
- Theft (such as, of intellectual property, financial assets, or toll facility access)
- Eavesdropping (privacy invasions to humans)
- Mischief (troubling, but apparently innocuous, tampering)
- Harm (such as harmful tampering, data loss or alteration, regardless of motive or intent)

Be aware that there may be a risk of unauthorized intrusions associated with your system and/or its networked equipment. Also realize that, if such an intrusion should occur, it could result in a variety of losses to your company (including but not limited to, human/data privacy, intellectual property, material assets, financial resources, labor costs, and/or legal costs).

### **Responsibility for Your Company's Telecommunications Security**

The final responsibility for securing both this system and its networked equipment rests with you - Avaya's customer system administrator, your telecommunications peers, and your managers. Base the fulfillment of your responsibility on acquired knowledge and resources from a variety of sources including but not limited to:

- Installation documents
- System administration documents
- Security documents
- Hardware-/software-based security tools
- Shared information between you and your peers
- Telecommunications security experts

To prevent intrusions to your telecommunications equipment, you and your peers should carefully program and configure:

- Your Avaya-provided telecommunications systems and their interfaces
- Your Avaya-provided software applications, as well as their underlying hardware/software platforms and interfaces
- Any other equipment networked to your Avaya products

### **TCP/IP Facilities**

Customers may experience differences in product performance, reliability and security depending upon network configurations/design and topologies, even when the product performs as warranted.

### **Standards Compliance**

Avaya Inc. is not responsible for any radio or television interference caused by unauthorized modifications of this equipment or the substitution or attachment of connecting cables and equipment other than those specified by Avaya Inc. The correction of interference caused by such unauthorized modifications, substitution or attachment will be the responsibility of the user. Pursuant to Part 15 of

the Federal Communications Commission (FCC) Rules, the user is cautioned that changes or modifications not expressly approved by Avaya Inc. could void the user's authority to operate this equipment.

### **Product Safety Standards**

This product complies with and conforms to the following international Product Safety standards as applicable:

Safety of Information Technology Equipment, IEC 60950, 3rd Edition including all relevant national deviations as listed in Compliance with IEC for Electrical Equipment (IECEE) CB-96A.

Safety of Information Technology Equipment, CAN/CSA-C22.2  
No. 60950-00 / UL 60950, 3rd Edition

Safety Requirements for Customer Equipment, ACA Technical Standard (TS) 001 - 1997

One or more of the following Mexican national standards, as applicable: NOM 001 SCFI 1993, NOM SCFI 016 1993, NOM 019 SCFI 1998

The equipment described in this document may contain Class 1 LASER Device(s). These devices comply with the following standards:

- EN 60825-1, Edition 1.1, 1998-01
- 21 CFR 1040.10 and CFR 1040.11.

The LASER devices operate within the following parameters:

- Maximum power output: -5 dBm to -8 dBm
- Center Wavelength: 1310 nm to 1360 nm

Luokan 1 Laserlaitte

Klass 1 Laser Apparat

Use of controls or adjustments or performance of procedures other than those specified herein may result in hazardous radiation exposures. Contact your Avaya representative for more laser product information.

### **Electromagnetic Compatibility (EMC) Standards**

This product complies with and conforms to the following international EMC standards and all relevant national deviations:

Limits and Methods of Measurement of Radio Interference of Information Technology Equipment, CISPR 22:1997 and EN55022:1998.

Information Technology Equipment – Immunity Characteristics – Limits and Methods of Measurement, CISPR 24:1997 and EN55024:1998, including:

- Electrostatic Discharge (ESD) IEC 61000-4-2
- Radiated Immunity IEC 61000-4-3
- Electrical Fast Transient IEC 61000-4-4
- Lightning Effects IEC 61000-4-5
- Conducted Immunity IEC 61000-4-6
- Mains Frequency Magnetic Field IEC 61000-4-8
- Voltage Dips and Variations IEC 61000-4-11
- Powerline Harmonics IEC 61000-3-2
- Voltage Fluctuations and Flicker IEC 61000-3-3

## Federal Communications Commission Statement

### Part 15:

**Note:** This equipment has been tested and found to comply with the limits for a Class A digital device, pursuant to Part 15 of the FCC Rules. These limits are designed to provide reasonable protection against harmful interference when the equipment is operated in a commercial environment. This equipment generates, uses, and can radiate radio frequency energy and, if not installed and used in accordance with the instruction manual, may cause harmful interference to radio communications. Operation of this equipment in a residential area is likely to cause harmful interference in which case the user will be required to correct the interference at his own expense.

### Part 68: Answer-Supervision Signaling

Allowing this equipment to be operated in a manner that does not provide proper answer-supervision signaling is in violation of Part 68 rules. This equipment returns answer-supervision signals to the public switched network when:

- answered by the called station,
- answered by the attendant, or
- routed to a recorded announcement that can be administered by the customer premises equipment (CPE) user.

This equipment returns answer-supervision signals on all direct inward dialed (DID) calls forwarded back to the public switched telephone network. Permissible exceptions are:

- A call is unanswered.
- A busy tone is received.
- A reorder tone is received.

Avaya attests that this registered equipment is capable of providing users access to interstate providers of operator services through the use of access codes. Modification of this equipment by call aggregators to block access dialing codes is a violation of the Telephone Operator Consumers Act of 1990.

### REN Number

#### For MCC1, SCC1, CMCI, G600, and G650 Media Gateways:

This equipment complies with Part 68 of the FCC rules. On either the rear or inside the front cover of this equipment is a label that contains, among other information, the FCC registration number, and ringer equivalence number (REN) for this equipment. If requested, this information must be provided to the telephone company.

#### For G350 and G700 Media Gateways:

This equipment complies with Part 68 of the FCC rules and the requirements adopted by the ACTA. On the rear of this equipment is a label that contains, among other information, a product identifier in the format US:AAAEQ##TXXXX. The digits represented by ## are the ringer equivalence number (REN) without a decimal point (for example, 03 is a REN of 0.3). If requested, this number must be provided to the telephone company.

**For all media gateways:**

The REN is used to determine the quantity of devices that may be connected to the telephone line. Excessive RENs on the telephone line may result in devices not ringing in response to an incoming call. In most, but not all areas, the sum of RENs should not exceed 5.0. To be certain of the number of devices that may be connected to a line, as determined by the total RENs, contact the local telephone company.

REN is not required for some types of analog or digital facilities.

**Means of Connection**

Connection of this equipment to the telephone network is shown in the following tables.

**For MCC1, SCC1, CMC1, G600, and G650 Media Gateways:**

| <b>Manufacturer's Port Identifier</b> | <b>FIC Code</b> | <b>SOC/REN/<br/>A.S. Code</b> | <b>Network Jacks</b>      |
|---------------------------------------|-----------------|-------------------------------|---------------------------|
| Off premises station                  | OL13C           | 9.0F                          | RJ2GX,<br>RJ21X,<br>RJ11C |
| DID trunk                             | 02RV2-T         | 0.0B                          | RJ2GX,<br>RJ21X           |
| CO trunk                              | 02GS2           | 0.3A                          | RJ21X                     |
|                                       | 02LS2           | 0.3A                          | RJ21X                     |
| Tie trunk                             | TL31M           | 9.0F                          | RJ2GX                     |
| Basic Rate Interface                  | 02IS5           | 6.0F, 6.0Y                    | RJ49C                     |
| 1.544 digital interface               | 04DU9-BN        | 6.0F                          | RJ48C,<br>RJ48M           |
|                                       | 04DU9-IKN       | 6.0F                          | RJ48C,<br>RJ48M           |
|                                       | 04DU9-ISN       | 6.0F                          | RJ48C,<br>RJ48M           |
| 120A4 channel service unit            | 04DU9-DN        | 6.0Y                          | RJ48C                     |

**For G350 and G700 Media Gateways:**

| <b>Manufacturer's Port Identifier</b> | <b>FIC Code</b> | <b>SOC/REN/<br/>A.S. Code</b> | <b>Network Jacks</b> |
|---------------------------------------|-----------------|-------------------------------|----------------------|
| Ground Start CO trunk                 | 02GS2           | 1.0A                          | RJ11C                |
| DID trunk                             | 02RV2-T         | AS.0                          | RJ11C                |
| Loop Start CO trunk                   | 02LS2           | 0.5A                          | RJ11C                |
| 1.544 digital interface               | 04DU9-BN        | 6.0Y                          | RJ48C                |
|                                       | 04DU9-DN        | 6.0Y                          | RJ48C                |
|                                       | 04DU9-IKN       | 6.0Y                          | RJ48C                |
|                                       | 04DU9-ISN       | 6.0Y                          | RJ48C                |
| Basic Rate Interface                  | 02IS5           | 6.0F                          | RJ49C                |

**For all media gateways:**

If the terminal equipment (for example, the media server or media gateway) causes harm to the telephone network, the telephone company will notify you in advance that temporary discontinuance of service may be required. But if advance notice is not practical, the telephone company will notify the customer as soon as possible. Also, you will be advised of your right to file a complaint with the FCC if you believe it is necessary.

The telephone company may make changes in its facilities, equipment, operations or procedures that could affect the operation of the equipment. If this happens, the telephone company will provide advance notice in order for you to make necessary modifications to maintain uninterrupted service.

If trouble is experienced with this equipment, for repair or warranty information, please contact the Technical Service Center at 1-800-242- 2121 or contact your local Avaya representative. If the equipment is causing harm to the telephone network, the telephone company may request that you disconnect the equipment until the problem is resolved.

A plug and jack used to connect this equipment to the premises wiring and telephone network must comply with the applicable FCC Part 68 rules and requirements adopted by the ACTA. A compliant telephone cord and modular plug is provided with this product. It is designed to be connected to a compatible modular jack that is also compliant. It is recommended that repairs be performed by Avaya certified technicians.

The equipment cannot be used on public coin phone service provided by the telephone company. Connection to party line service is subject to state tariffs. Contact the state public utility commission, public service commission or corporation commission for information.

This equipment, if it uses a telephone receiver, is hearing aid compatible.

**Canadian Department of Communications (DOC) Interference Information**

This Class A digital apparatus complies with Canadian ICES-003.

Cet appareil numérique de la classe A est conforme à la norme NMB-003 du Canada.

This equipment meets the applicable Industry Canada Terminal Equipment Technical Specifications. This is confirmed by the registration number. The abbreviation, IC, before the registration number signifies that registration was performed based on a Declaration of Conformity indicating that Industry Canada technical specifications were met. It does not imply that Industry Canada approved the equipment.

**Declarations of Conformity**

United States FCC Part 68 Supplier's Declaration of Conformity (SDoC)

Avaya Inc. in the United States of America hereby certifies that the equipment described in this document and bearing a TIA TSB-168 label identification number complies with the FCC's Rules and Regulations 47 CFR Part 68, and the Administrative Council on Terminal Attachments (ACTA) adopted technical criteria.

Avaya further asserts that Avaya handset-equipped terminal equipment described in this document complies with Paragraph 68.316 of the FCC Rules and Regulations defining Hearing Aid Compatibility and is deemed compatible with hearing aids.

Copies of SDoCs signed by the Responsible Party in the U. S. can be obtained by contacting your local sales representative and are available on the following Web site: <http://www.avaya.com/support>.

All Avaya media servers and media gateways are compliant with FCC Part 68, but many have been registered with the FCC before the SDoC process was available. A list of all Avaya registered products may be found at: <http://www.part68.org> by conducting a search using "Avaya" as manufacturer.

### **European Union Declarations of Conformity**



Avaya Inc. declares that the equipment specified in this document bearing the "CE" (*Conformité Européenne*) mark conforms to the European Union Radio and Telecommunications Terminal Equipment Directive (1999/5/EC), including the Electromagnetic Compatibility Directive (89/336/EEC) and Low Voltage Directive (73/23/EEC). This equipment has been certified to meet CTR3 Basic Rate Interface (BRI) and CTR4 Primary Rate Interface (PRI) and subsets thereof in CTR12 and CTR13, as applicable.

Copies of these Declarations of Conformity (DoCs) can be obtained by contacting your local sales representative and are available on the following Web site: <http://www.avaya.com/support>.

### **Japan**

This is a Class A product based on the standard of the Voluntary Control Council for Interference by Information Technology Equipment (VCCI). If this equipment is used in a domestic environment, radio disturbance may occur, in which case, the user may be required to take corrective actions.

この装置は、情報処理装置等電波障害自主規制協議会（VCCI）の基準に基づくクラスA情報技術装置です。この装置を家庭環境で使用すると電波妨害を引き起こすことがあります。この場合には使用者が適切な対策を講ずるよう要求されることがあります。

### **To order copies of this and other documents:**

Call: Avaya Publications Center  
Voice 1.800.457.1235 or 1.207.866.6701  
FAX 1.800.457.1764 or 1.207.626.7269

Write: Globalware Solutions  
200 Ward Hill Avenue  
Haverhill, MA 01835 USA  
Attention: Avaya Account Management

E-mail: [totalware@gwsmail.com](mailto:totalware@gwsmail.com)

For the most current versions of documentation, go to the Avaya support Web site: <http://www.avaya.com/support>.



## - Process and Specifications -

- 1 *Verifying the Equipment*
- 2 *Installing the Hardware*
- 3 *Connecting the Cables*
- 4 *Configuring the UPS and the Ethernet Switch*
- 5 *Connecting the Laptop*
- 6 *Connecting to the G650 Media Gateway*
- 7 *Troubleshooting*

### *Hardware Specifications*

| <u>Equipment</u> | <u>Weight</u>       |                    | <u>Dimensions</u>   |                    | <u>Us</u> |
|------------------|---------------------|--------------------|---------------------|--------------------|-----------|
|                  | <u>English (lb)</u> | <u>Metric (kg)</u> | <u>English (in)</u> | <u>Metric (cm)</u> |           |
| S8700 Servers    | 23                  | 10.5               | 3.5 x 17 x 17       | 9 x 43 x 43        | 2         |
| S8710 Servers    | 60                  | 27                 | 3.4 x 26 x 17.5     | 8.6 x 66 x 45      | 2         |
| UPS              | >34                 | >15                | 3.5 x 17 x 19       | 9 x 43 x 48        | 2         |
| Ethernet switch  | 16.5                | 7.5                | 3.5 x 17 x 18       | 9 x 43 x 46        | 2         |

# - Legend -



*Avaya technician  
or business partner*



*Customer*



*Product  
documentation*



*Green  
straight-through  
CAT5 cable*

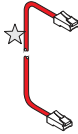

*Red  
straight-through  
CAT5 cable*



*Crossover  
CAT5 cable*



*Services  
laptop*

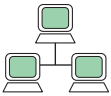

*Customer  
network*

2

*Sequence step*

D

*Duplex  
reliability*

H/C

*High / Critical  
reliability*



*Nonswitched  
electrical outlet*



*System  
administration*



*Filled-out Electronic  
Pre-Installation  
Worksheet (EPW)*



*Anti-static  
wrist ground strap  
required*



*Warning!  
Use 2 people  
to lift equipment*

# 1 Verifying the Equipment



Product documentation



PCMCIA flashcard (S8700)



Compact flash (S8710)



Modem (2)

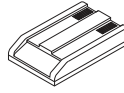

Services laptop

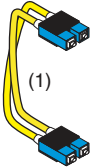

(1)

Fiber cable

CAT5

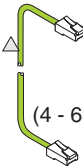

(4 - 68)

IPSI control network cables

CAT5

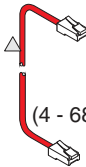

(4 - 68)

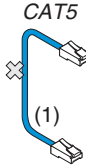

(1)

Duplication cable

CAT5

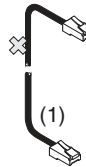

(1)

Laptop to server cable

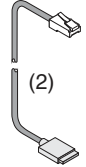

(2)

Modem cable

Cross-point screwdriver

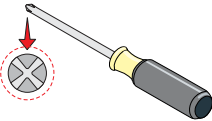

Hex-head wrench (1/8 in., 3 mm) (S8700 only)



IPSI adapter (1 - 128)

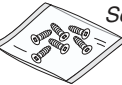

Screws

SNMP module and cable (2)

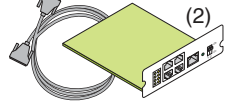

S8700 media server (2)

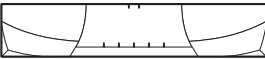

OR

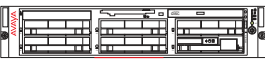

S8710 media server (2)

Ethernet switch\* (1 or more)

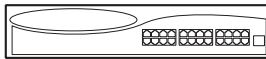

UPS\* (2)

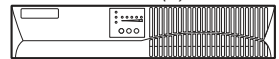

Ethernet switch\*

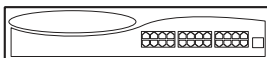

(1 or more)

UPS\*

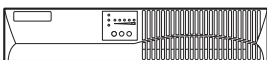

(2)

Customer network

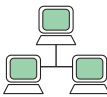

System administration and filled-out Electronic Pre-Installation Worksheet

19 in. (48.3 cm) S8700 data rack (1)

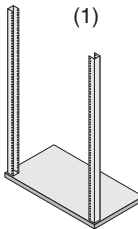

19 in. (48.3 cm) S8710 data rack (1)

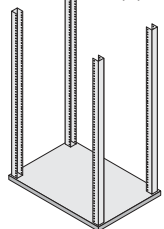

Screws

\*Optional

## 2a Installing the Hardware: SNMP Module

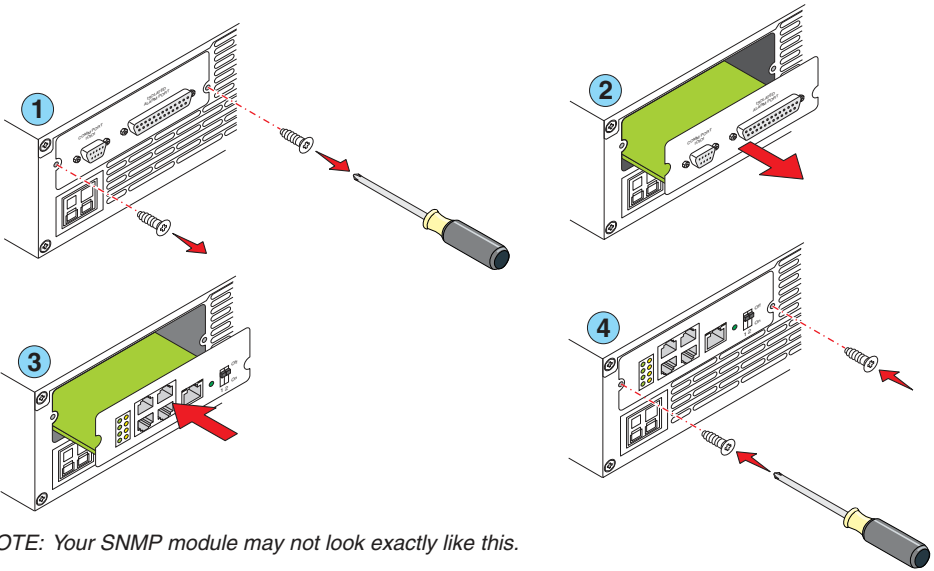
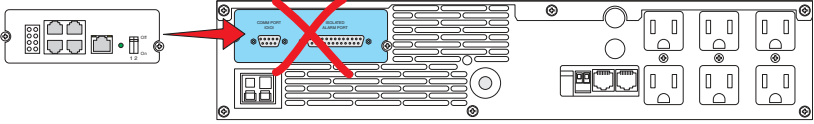

NOTE: Your SNMP module may not look exactly like this.

## 2b Installing the Hardware: Mounting Brackets\*

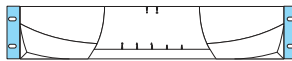
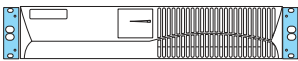

8700

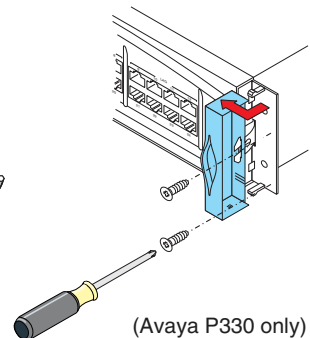
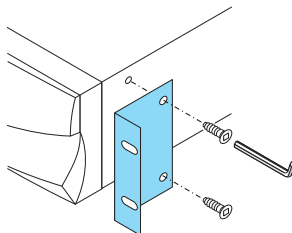
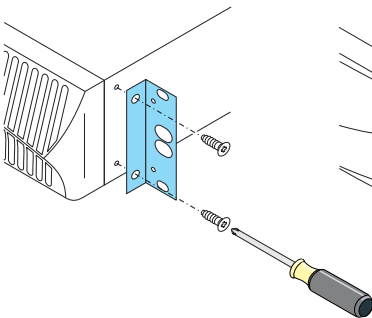
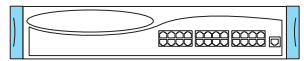

(Avaya P330 only)

\* For S8710, see 2C.

2c

## Installing the Hardware: Rail Installation to the Server (S8710)

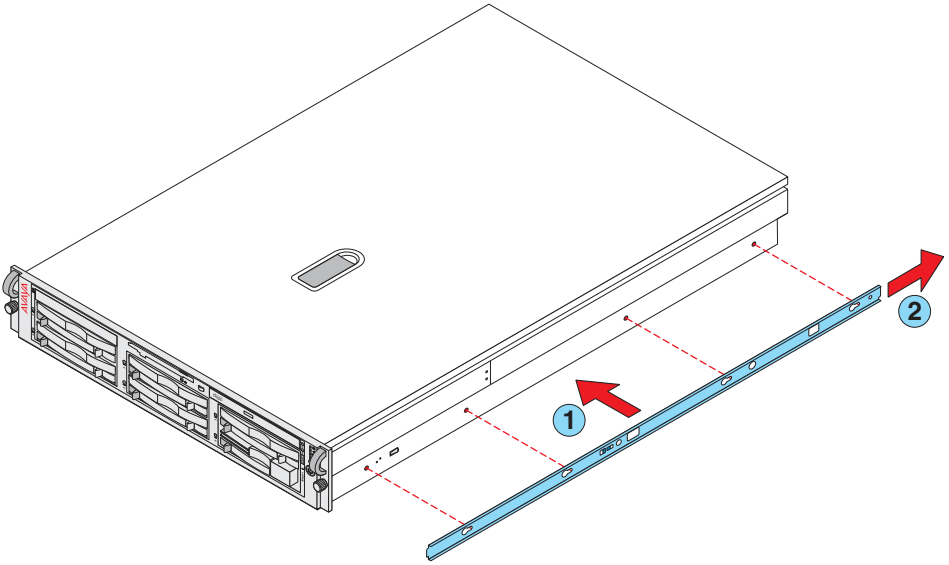

**2d** *Installing the Hardware: Attaching Rails to the Rack (S8710)*

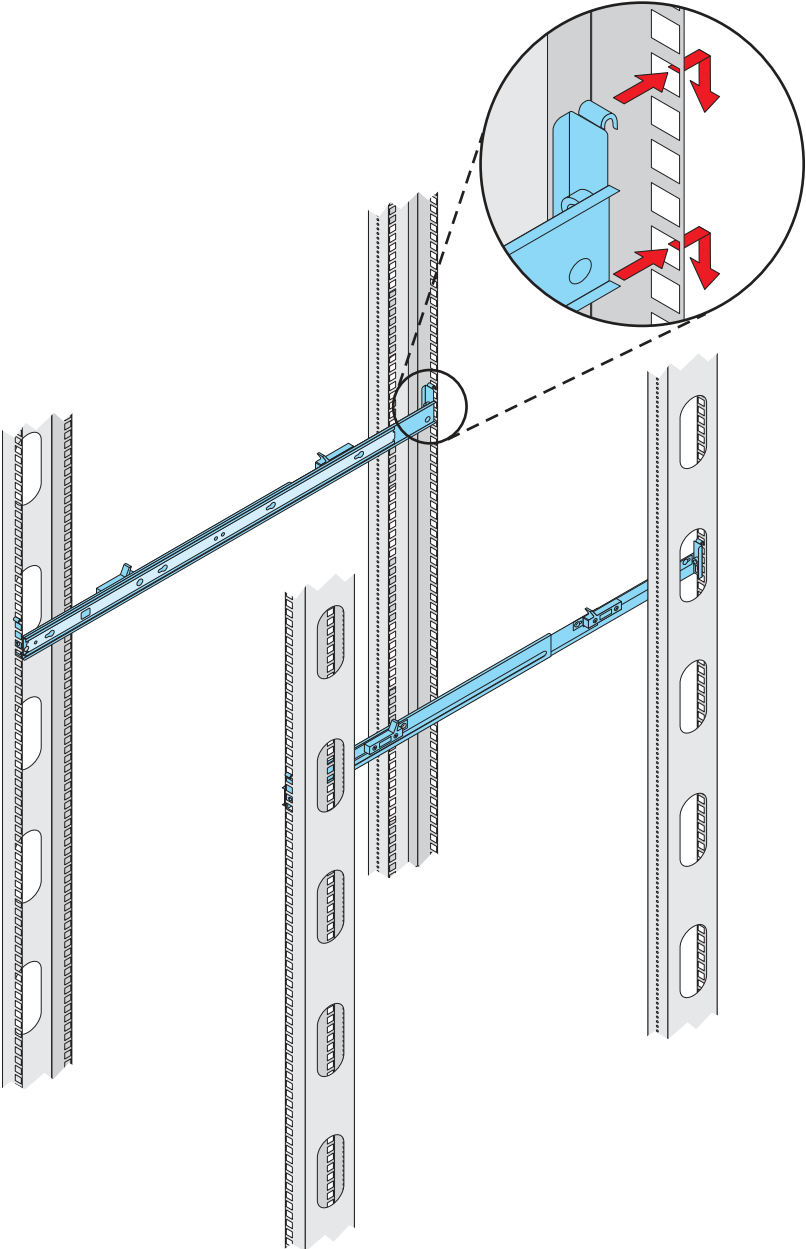

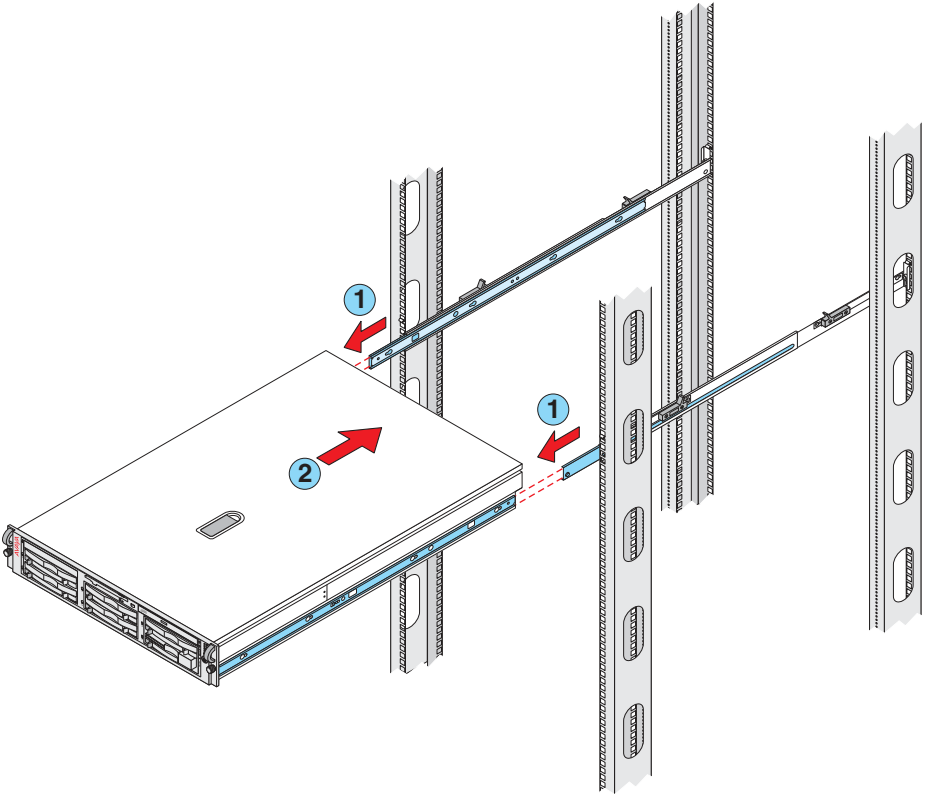

## 2f Installing the Hardware: Rack Installation (S8700)

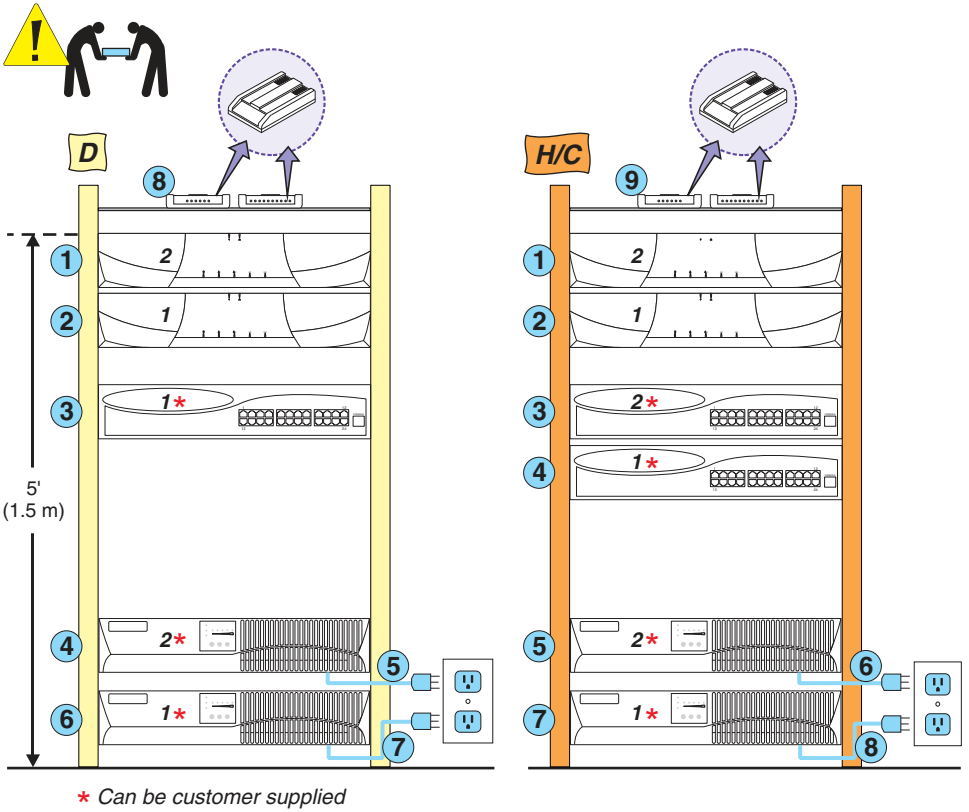



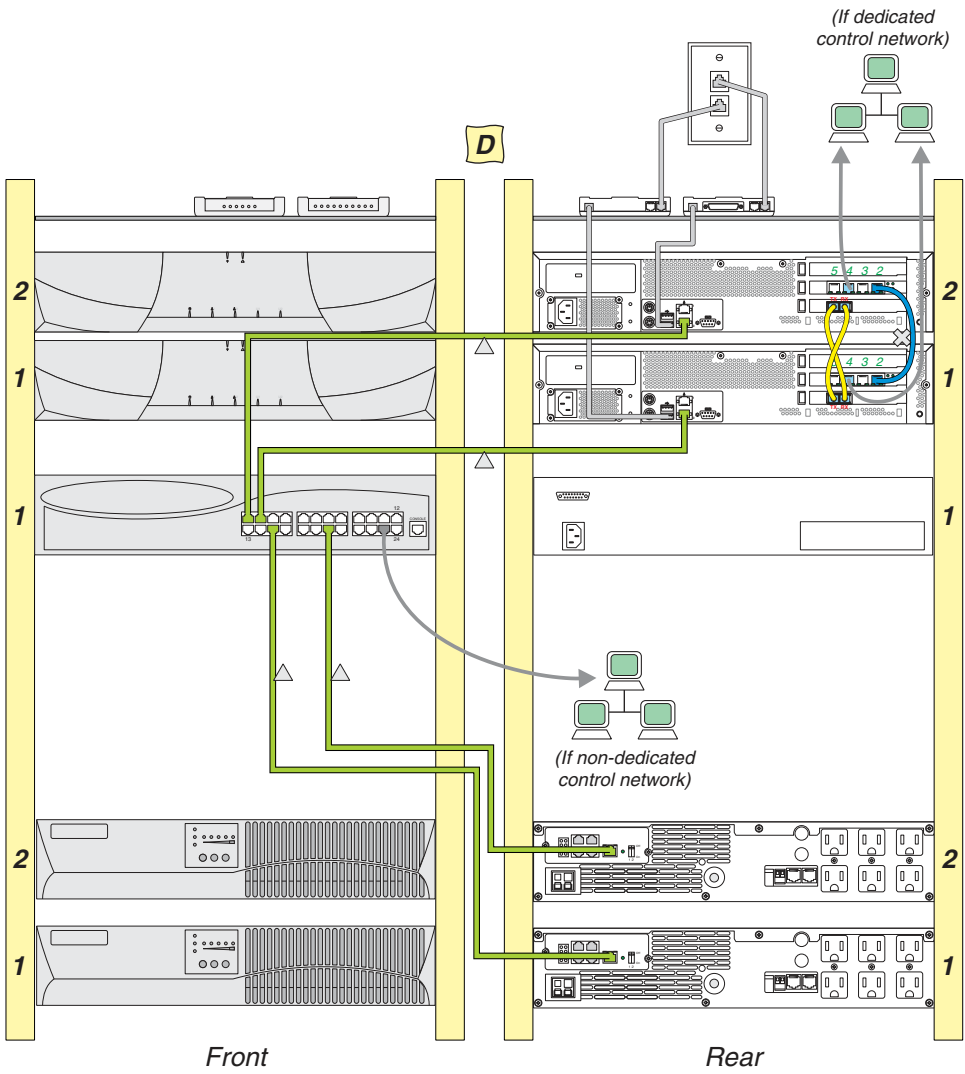

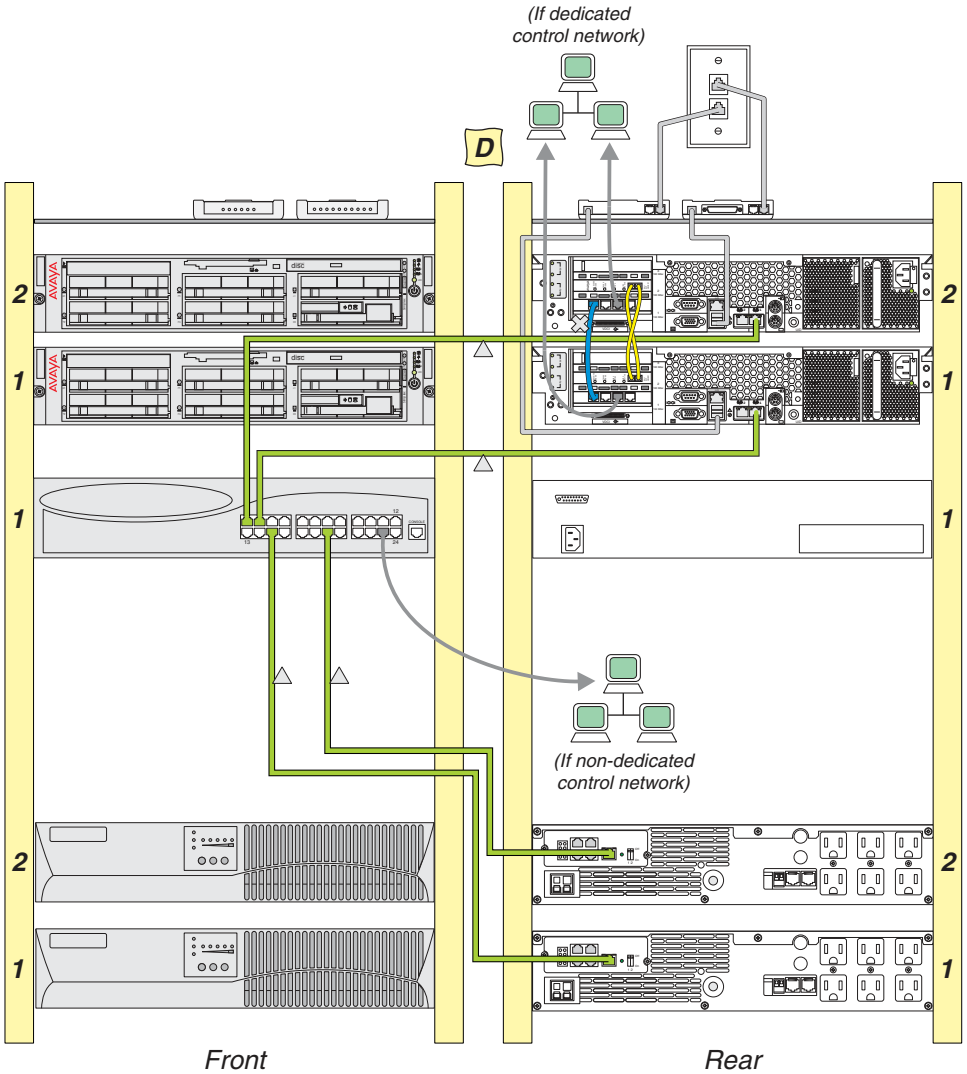

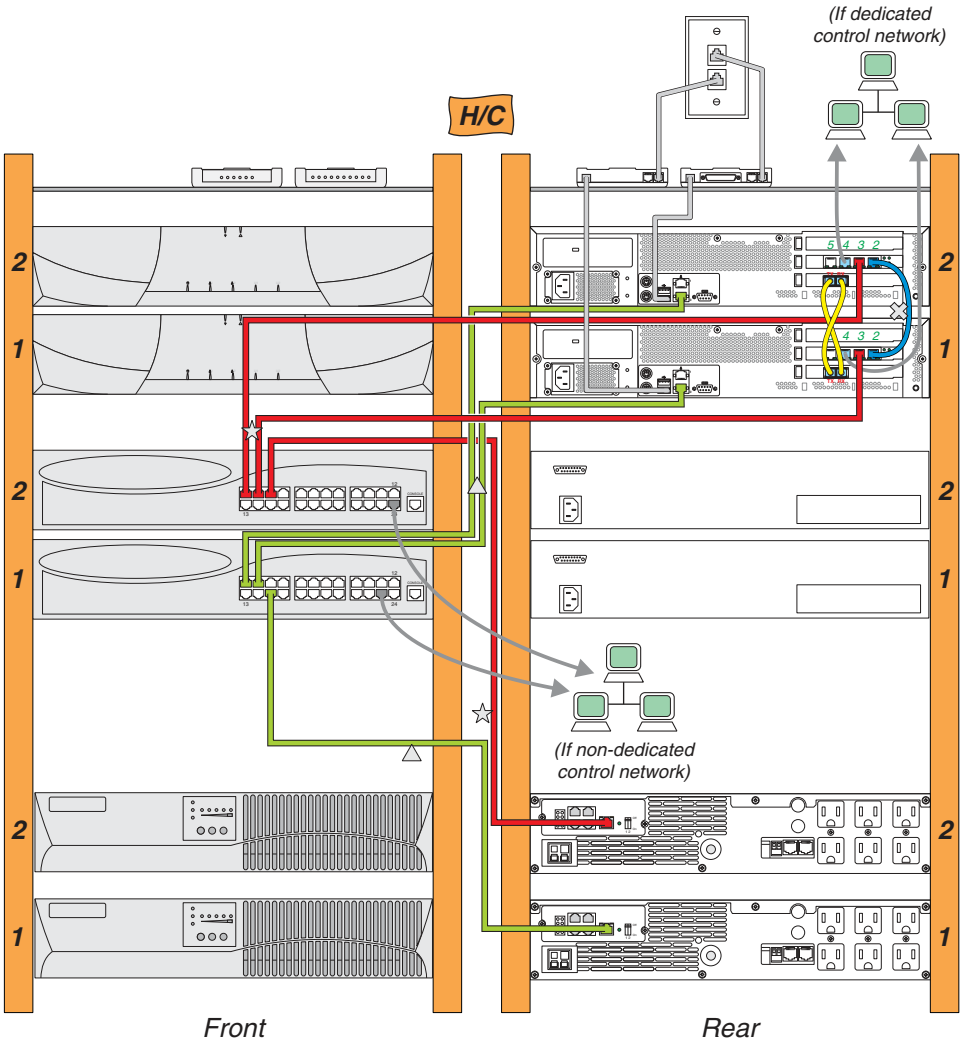

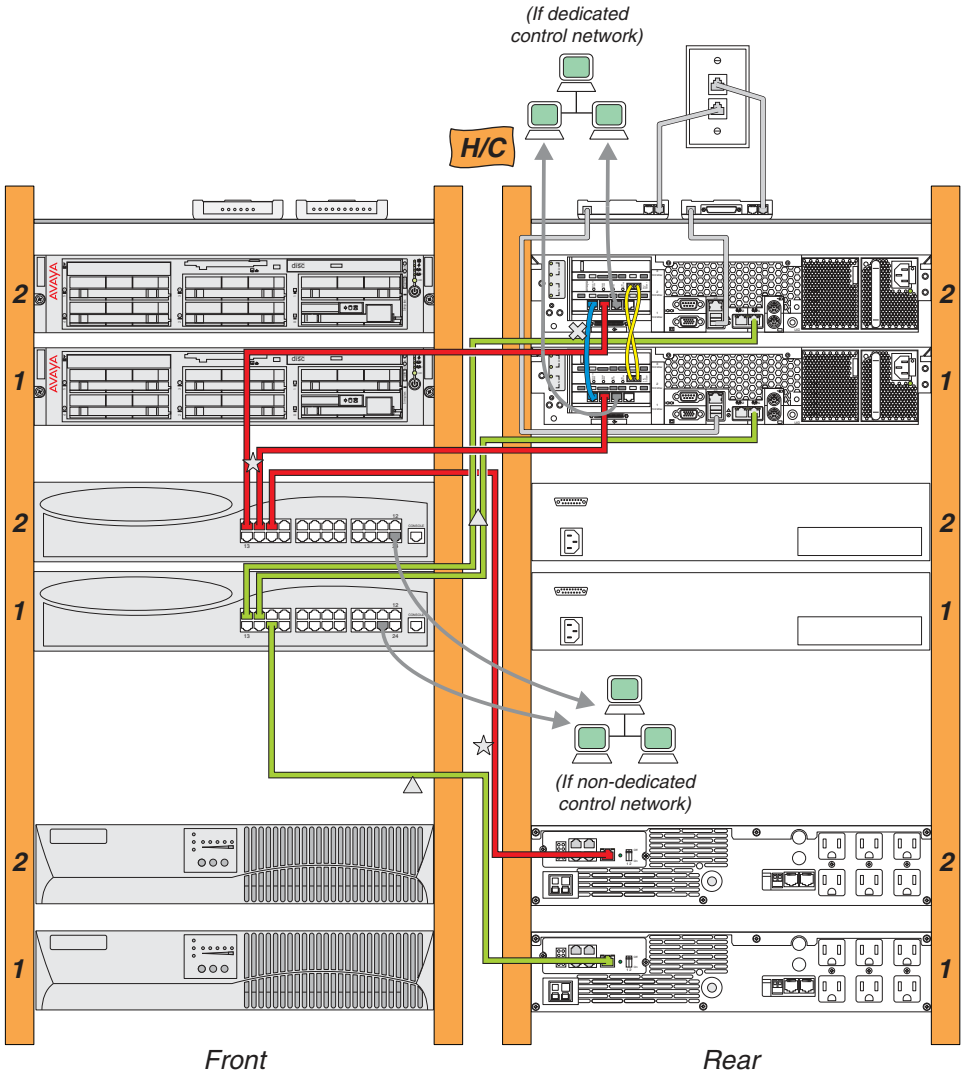

### 3e *Configuring the Hardware: Duplication Cabling (S8700)*

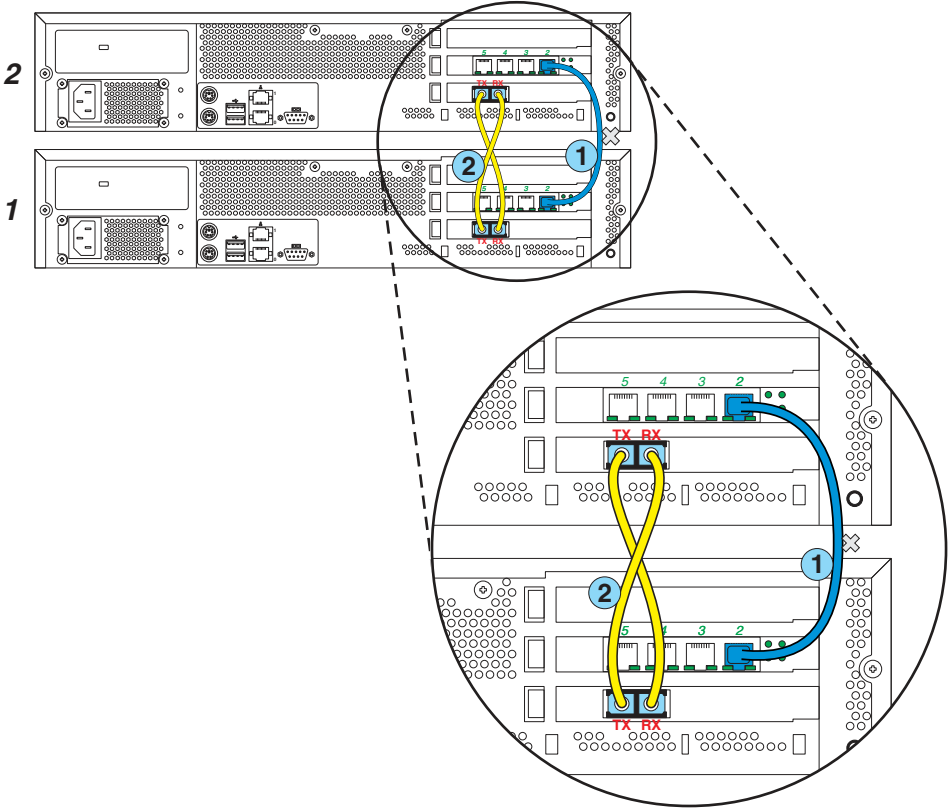

### 3f *Configuring the Hardware: Duplication Cabling (S8710)*

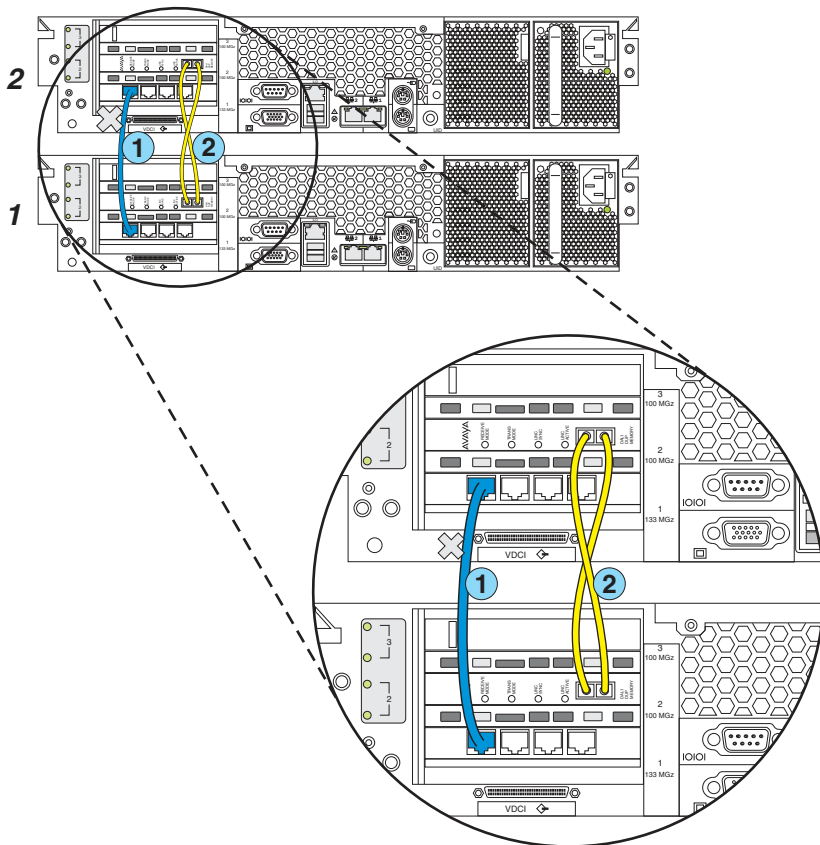

# 4a Configuring the UPS\* and the Ethernet Switch

\*If Avaya-supplied

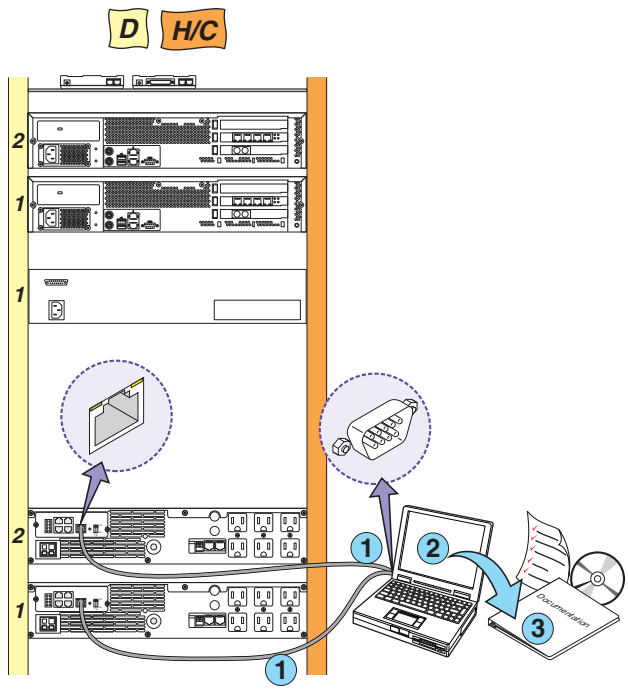

\*If Avaya-supplied

**D**

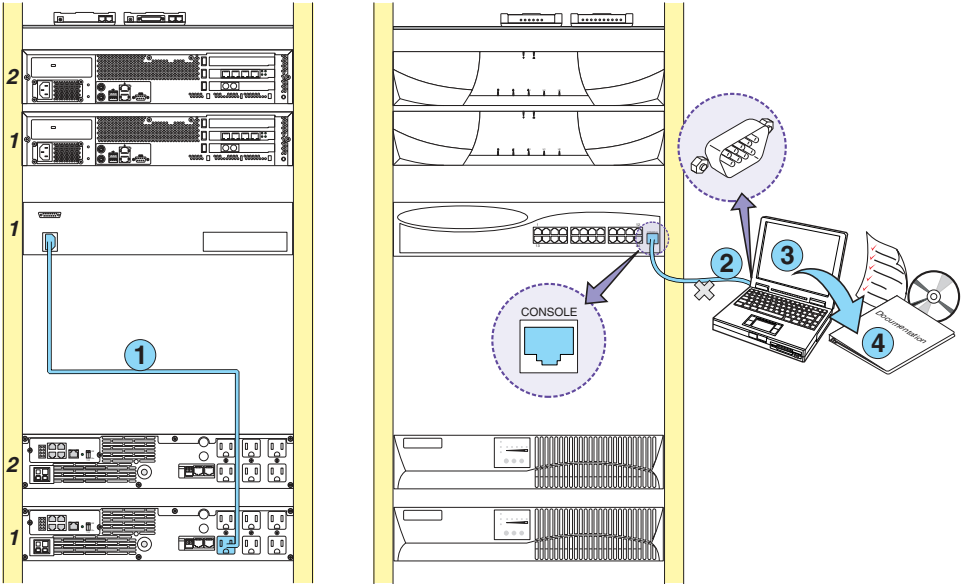

**H/C**

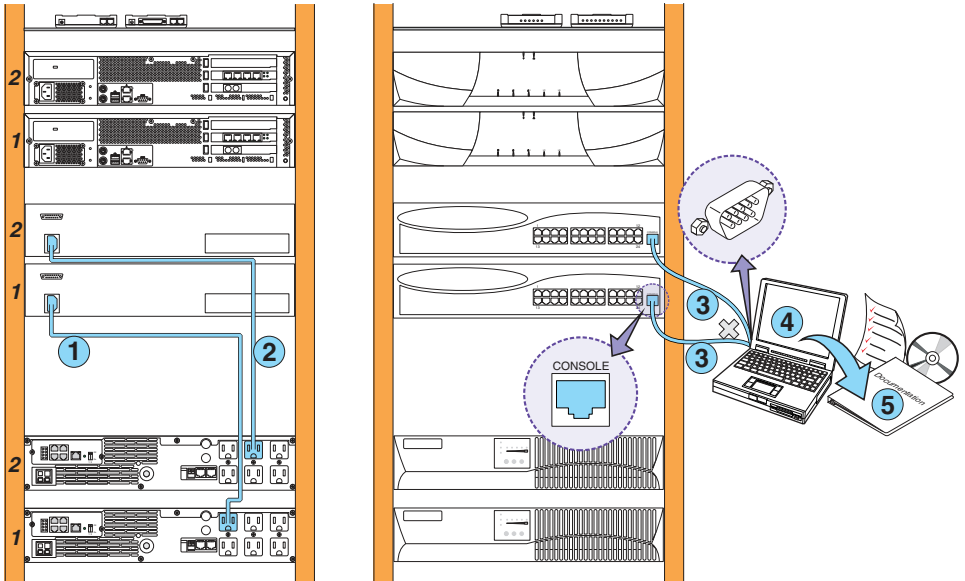



## 5a Connecting the Laptop (S8700)

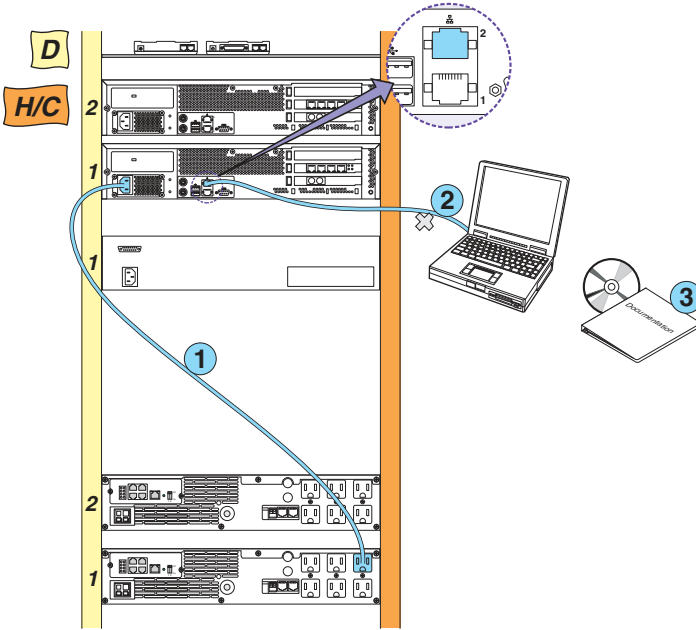

## 5b Connecting to Laptop (S8700)

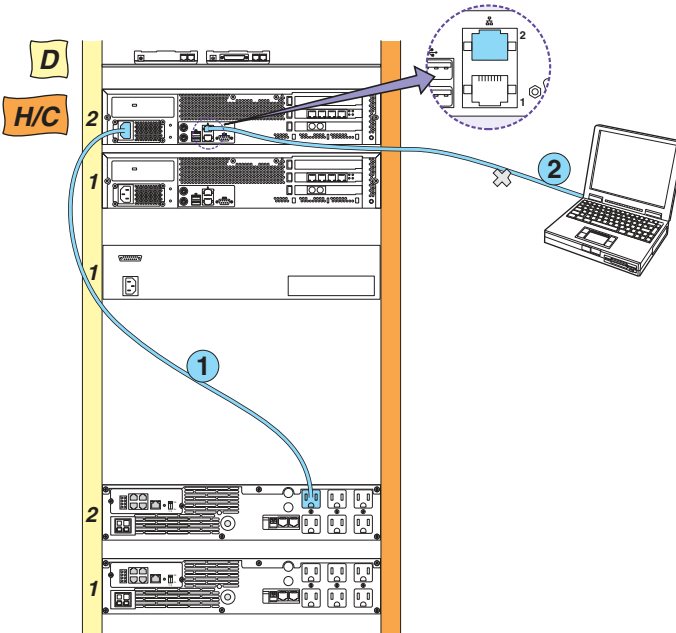

**5c** *Connecting the Laptop (S8710)*

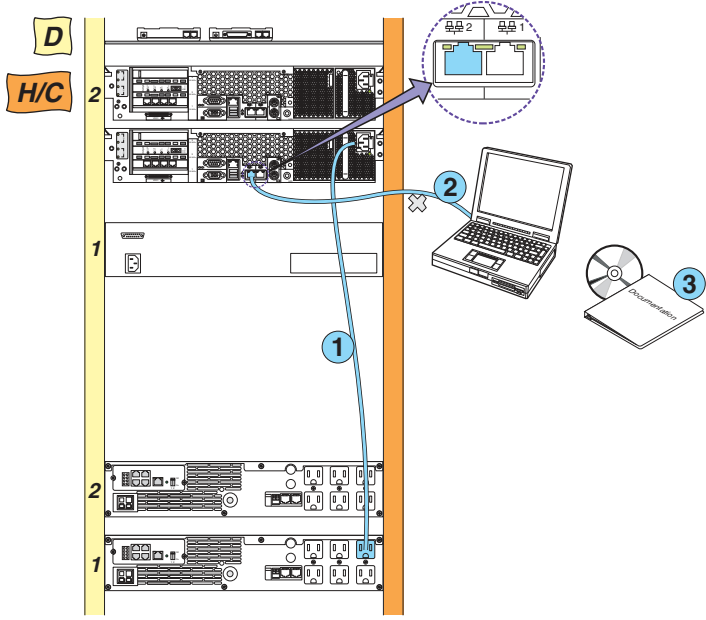

**5d** *Connecting to Laptop (S8710)*

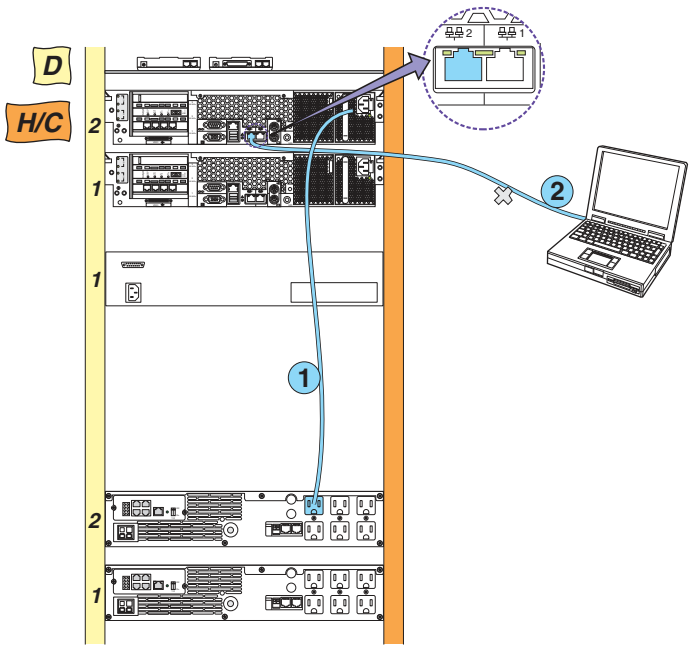

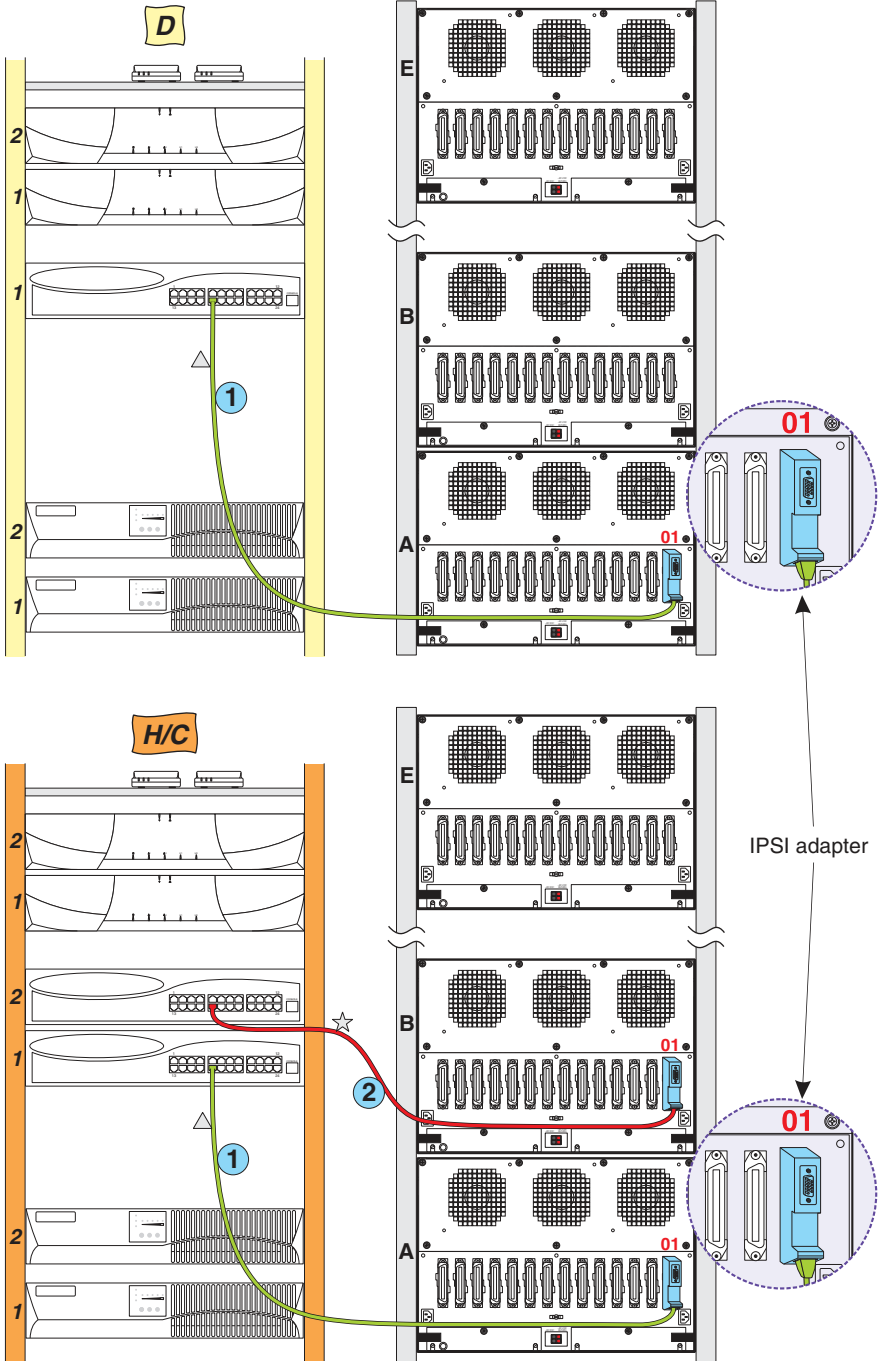

| Problem:  | Solution:   |
|---|---|
| • Avaya equipment is missing                                    | • Contact the project manager   |
| • Customer equipment is missing                                 | • Contact the project manager   |
| • Customer network information is missing                       | • Contact the project manager   |
| • No power to the UPS   | <ul style="list-style-type: none"> <li>• Is the UPS plugged into the outlet?</li> <li>• Does the outlet have power?</li> </ul>  |
| • The alarm LEDs on the UPS are flashing                        | • Refer to the UPS user's guide   |
| • No power to the Avaya-supplied ethernet switch                | <ul style="list-style-type: none"> <li>• Is the switch plugged into the UPS?</li> <li>• Does the UPS have power?</li> </ul>   |
| • Alarm LEDs on the Avaya-supplied ethernet switch are flashing | • Refer to the Avaya-supplied ethernet switch user's guide  |
| • No power to the media server                                  | <ul style="list-style-type: none"> <li>• Is the media server plugged into the UPS?</li> <li>• Does the UPS have power?</li> <li>• Push the power button on the media server to start</li> </ul> |
| • The green status LED on the server is flashing slow           | • The server is in the standby mode   |
| • No V on the IPSI LCD  | • Check the connection to the network   |