



6408+, 6408D+, 6416D+, 6416D+M, 6424D+, and 6424D+M Telephones

User's Guide

Contents

6400 Series Multi-line Telephones	5
Headsets	6
Headpieces	7
Using the Softkeys	8
Using the Softkey Feature Menus	8
Other Softkey Features That May Be On Your Display ..	9
Call-Handling Features	9
Getting Messages	13
Selecting a Personalized Ring	13
Selected Voice Features	14
Display Features	21
Time and Date	21
Call Information	21
Modular Interface Capabilities	24
Telephone Installation	25
Desktop Installation	25
Wall Installation	26
Removing the Telephone Tray	29
Installing the Designation Card	30
Line and Feature Button Lights	32

Some versions of DCP display telephones are intended for export outside of the U.S. These telephones initialize with "EXPORT VERSION" on the display. Display features are not operative until after this display disappears.

If the "EXPORT VERSION" display does not disappear within a few seconds, activate the Test function by pressing the Transfer button. If this action does not remove the "EXPORT VERSION" display, contact your system administrator.

NOTICE

While reasonable efforts were made to ensure that the information in this document was complete and accurate at the time of printing, Avaya can assume no responsibility for any errors. Changes or corrections to the information contained in this document may be incorporated into future issues.

ORDERING INFORMATION

Call: Avaya Publications Center
US Voice:1 800 457 1235
US Fax:1 800 457 1764
non-US Voice:+1 207 866 6701
non-US Fax:+1 207 626 7269

Write: Globalware Solutions
200 Ward Hill Avenue
Haverhill, MA 01835 USA

HEARING AID COMPATIBILITY

The 6400-Series telephones are Hearing Aid Compatible (HAC), and thus all units have "HAC" printed on them.

YOUR RESPONSIBILITY FOR YOUR SYSTEM'S SECURITY

You are responsible for the security of your system. Avaya does not warrant that this product is immune from or will prevent unauthorized use of common-carrier telecommunication services or facilities accessed through or connected to it. Avaya will not be responsible for any charges that result from such unauthorized use. Product administration to prevent unauthorized use is your responsibility and your system manager should read all documents provided with this product to fully understand the features available that may reduce your risk of incurring charges.

TRADEMARKS

DEFINITY and AUDIX are registered trademarks of Avaya, Inc.
Mirage, Star Set, and Supra are registered trademarks of Plantronics, Inc.

THE "CE" MARK

If the "CE" mark is affixed to this equipment, it means that it conforms to the European Union Electromagnetic Compatibility Directive (89/336/EEC) and the Low Voltage Directive (73/23/EEC).

Prepared by
BCS Product Publications
Middletown, New Jersey 07748-1998

© 1999 Avaya, Inc.
All Rights Reserved
Printed in USA

IMPORTANT USER SAFETY INSTRUCTIONS

The most careful attention has been devoted to quality standards in the manufacture of your new telephone. Safety is a major factor in the design of every set. But, safety is YOUR responsibility too.

Please read carefully the helpful tips listed below and on the next page. These suggestions will enable you to take full advantage of your new voice terminal. Then, retain these tips for later use.



CAUTION:

This telephone is NOT for residential use. It is for business systems applications ONLY. It will NOT operate on public networks. It MUST BE connected to a DEFINITY Enterprise Communications Server. Use in a residential environment could result in an electrical short circuit when the telephone wiring is set up to provide other applications, for example, for appliance control or power transformers. The AC power used in these applications may create a safety hazard by placing a direct short circuit across the telephone wiring.

Use

When using your telephone equipment, the following safety precautions should always be followed to reduce the risk of fire, electric shock, and injury to persons.

- Read and understand all instructions.
- Follow all warnings and instructions marked on the telephone.
- This telephone can be hazardous if immersed in water. To avoid the possibility of electric shock, do not use it while you are wet. If you accidentally drop the telephone into water, do not retrieve it until you have first unplugged the line cord from the modular wall jack. Then, call service personnel to ask about a replacement.
- Avoid using the telephone during electrical storms in your immediate area. There is a risk of electric shock from lightning. Urgent calls should be brief. Even though protective measures may have been installed to limit electrical surges from entering your business, absolute protection from lightning is impossible.
- If you suspect a natural gas leak, report it immediately, but use a telephone away from the area in question. The telephone's electrical contacts could generate a tiny spark. While unlikely, it is possible that this spark could ignite heavy concentrations of gas.
- Never push objects of any kind into the equipment through housing slots since they may touch hazardous voltage points or short out parts that could result in a risk of electric shock. Never spill liquid of any kind on the telephone. If liquid is spilled, however, refer servicing to proper service personnel.

- To reduce the risk of electric shock, do not disassemble this telephone. There are no user serviceable parts. Opening or removing covers may expose you to hazardous voltages. Incorrect reassembly can cause electric shock when the telephone is subsequently used.

Service

1. Before cleaning, unplug the telephone from the modular wall jack. Do not use liquid cleaners or aerosol cleaners. Use a damp cloth for cleaning.
2. Unplug the telephone from the modular wall jack. Be sure to refer servicing to qualified service personnel when these conditions exist:
 - If liquid has been spilled into the telephone.
 - If the telephone has been exposed to rain or water.
 - If the telephone has been dropped or the housing has been damaged.
 - If you note a distinct change in the performance of the telephone.

SAVE THESE INSTRUCTIONS



When you see this warning symbol on the product, refer to this instructions booklet packed with the product for more information before proceeding.

6400 Series Multi-line Telephones

The 6400 Series multi-line telephones include the following:

- **The 6408+ Telephone** — has eight call appearance/feature buttons with a two-way speakerphone.
- **The 6408D+ Telephone** — has eight call appearance/feature buttons, a 2-line by 24-character display, and a two-way speakerphone.
- **The 6416D+ and 6416D+M Telephones** — have 16 call appearance/feature buttons, a 2-line by 24-character display, and a two-way speakerphone.
- **The 6424D+ and 6424D+M Telephones** — have 24 call appearance/feature buttons, a 2-line by 24-character display, and a two-way speakerphone.

Note: Only the 6416D+M and 6424D+M have modular capabilities. For more information on this feature, see [“Modular Interface Capabilities”](#) on page 24.

Use [Figure 1](#) below to familiarize yourself with your 6400 Series telephone. (The 6408D+ is shown in [Figure 1](#).)

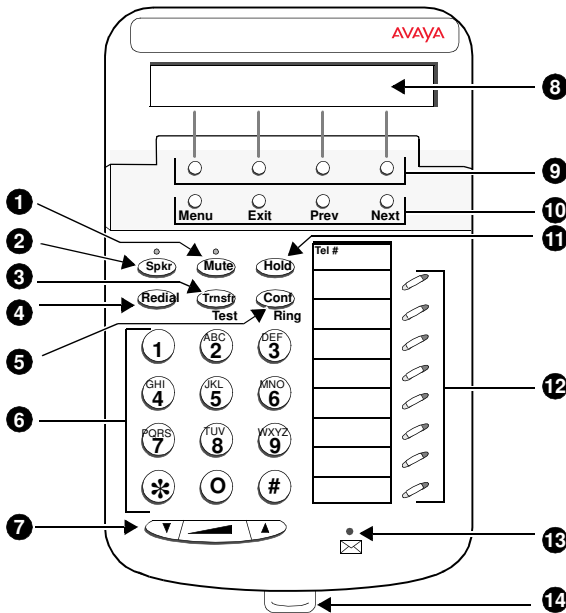



FIGURE 1 The 6408D+ Telephone

The following features correspond to the numbers in [Figure 1](#).

1) Mute button	8) Display — available only on the 6408D+, 6416D+ and 6416D+M, and the 6424D+ and 6424D+M
2) Speaker button	9) Softkeys
3) Transfer/Test button	10) Display control buttons
4) Redial button	11) Hold button
5) Conf/Ring button	12) Call appearance/feature buttons
6) Dial pad	13) Message light — labeled 
7) Volume control button	14) Tray handle

Headsets

On all of the 6400 Series telephones *except* the 6416D+M and 6424D+M, the headset connection consists of a headpiece (shown as **1** in [Figure 2](#) below) and modular base unit (shown as **2** in [Figure 2](#)). In this instance, the base unit plugs into the Handset jack (shown as **3** in [Figure 2](#)).

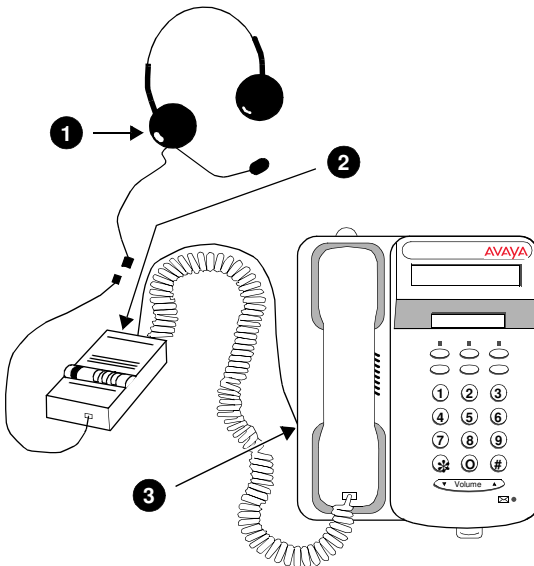

FIGURE 2 The Headset Attached to the Handset Jack on a 6400 Series Telephone (via a Modular Base Unit)

On the 6416D+M and 6424D+M sets, there is a jack provided for *ONLY* the headset. In [Figure 3](#), the headset is shown as **1**; the Headset jack is shown as **2**. On these sets, the headset can *either* be connected, with an adapter cord (shown as **3** in [Figure 3](#)), to the Headset jack on the back of the telephone *or* connected to a modular base unit which then plugs into the Headset jack.

Note: When a modular base unit is used with the Headset jack, the handset should remain plugged into the Handset jack.

The privacy of the Whisper Page announcement cannot be guaranteed when telephones have modular base units other than the M10L-8400 (Comcode: 407639715; PEC: 3122-022). The M10L-8400 is the only modular base unit that should be used for the 6400 Series telephones. Note that this does NOT apply to headsets plugged into the Headset jack on the back of the 6416D+M and 6424D+M telephones that do not require a modular base. For more information, see the instructions for the Whisper Page feature in the **Voice Features** section.

Note: If you plug the headset directly into the Headset jack, you may use a button on the adapter cord, if so equipped, to go off-hook and on-hook, or a **Headset On/Off** button may be administered.

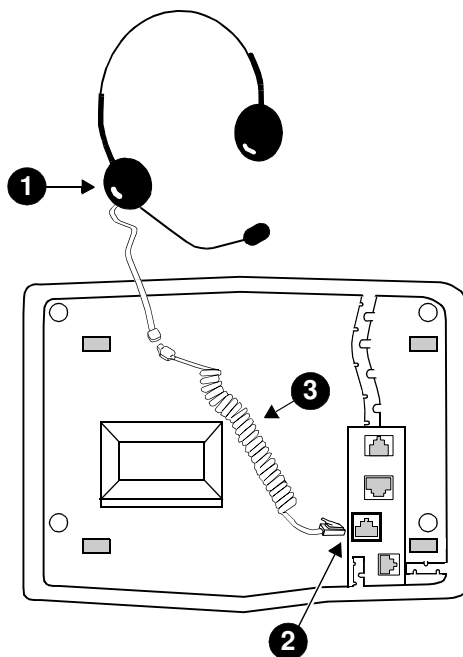

FIGURE 3 The Headset Connected to the Headset Jack on the 6416D+M and 6424D+M Telephones (No Modular Base Unit Required)

Headpieces

The following headpieces can be used with these telephones:

Headpieces with Modular Bases or with Adapter Cords

- **Mirage®** — Receiver fits over either ear. Not for noisy environments.
- **StarSet®** — Eartip fits in ear canal.
- **Supra® Monaural** — Adjustable headband and soft ear cushion.

- **Supra Monaural Noise-Canceling (NC)** — Same as above with noise-canceling microphone that reduces background noise transmission by up to 75 percent.
- **Supra Binaural** — Sound in both ears.
- **Supra Binaural Noise-Canceling (NC)** — Same as above with noise-canceling microphone on flexible boom; features windscreen and reduces background noise transmission by up to 75 percent.

Note: For direct connection to the Headset jack on the 6416D+M and 6424D+M, use the following cord: HIC-01; Comcode: 408122950; PEC: 3124-IC/A.

Using the Softkeys

The softkeys are the four unlabeled round keys located directly below the display. The four round display control buttons, labeled **Menu**, **Exit**, **Prev**, and **Next** are located under the softkeys. See [Figure 4](#).

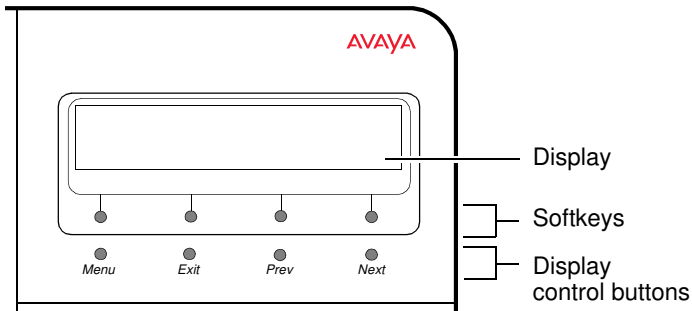
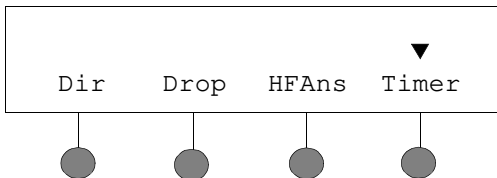

FIGURE 4 The Display, Softkeys, and Display Control Buttons

Using the Softkey Feature Menu

There are three separate softkey feature menus. Each of these menus allows you to select from four different features.

You can enter Softkey Mode (and view the softkey feature menu) by pressing the display control button labeled **Menu**. The following is an example of a softkey feature menu.



The **top line** of each softkey feature menu screen shows you the status of each of the four features. An arrow appears above the feature name or abbreviation if that feature is active. In the above example, the arrow above the Timer feature indicates that feature is active.

The **second line** on each softkey feature menu shows the features you can access. To use any of these features, you must press the softkey below the feature name or abbreviation.

Press the **Next** or **Prev** button until the feature you want to use appears on the display.

Note: An error tone (one beep) sounds when you have made an inappropriate softkey entry.

Press the **Exit** button at any time to exit the softkey feature menus and return to normal call-handling operation.

Other Softkey Features That May Be On Your Display

There are 12 default features that can be accessed with the softkeys on a 6400 Series telephone. However, the system manager may substitute other softkey features in their place.

Call-Handling Features

Conference

The Conference feature allows you to conference up to six parties (including yourself) on a call.

To add another party to a call (for a total of six parties)

1. Press **Conf**. [*dial tone*]
2. Dial the number of the new party and wait for an answer.
3. When you want to add the new person, press **Conf** again.
4. Repeat Steps 1 through 3 for additional conference connections.

To add a call you have put on hold to another call you are connected to

1. Press **Conf**. [*dial tone*]
2. Press the call appearance button of the call on hold (first call).
3. Press **Conf** again.

To drop the last person added to the conference call

1. **With a display:** Press the **Menu** button and then press the softkey below **Drop**.

Without a display: Press the **Drop** button (if administered).

Hold

The Hold feature puts a call on hold until you can return to it.

To put a call on hold while you answer another call or perform another task

1. Press **Hold**.

To answer a new call while active on another

1. Press **Hold**.
2. Press the call appearance button of the incoming call.

To return to the held call

1. Press the call appearance button of the held call.

Note: If your telephone is connected to DEFINITY Release 7.1 or a later release and if there is only one call on hold at your telephone, you can transfer the call or initiate a conference call by pressing **Trnsfr** or **Conf** *without* first returning to the held call.

Redial

The Redial (or Last Number Dialed) feature automatically redials the last extension or outside number (up to 24 digits) you dialed.

To redial the last number that you dialed



1. Press **Redial**.

Speaker (Listen-Only) and Group Listen

The Speaker feature allows you to place calls or access other features without lifting the handset. However, in order to speak to the other party, you must use the handset. With the Group Listen feature, the handset and speaker are active at the same time.

Note: All of the 6400 Series telephones described in this manual can be optioned for either a two-way *speakerphone* or a one-way, listen-only *speaker*. Check with your system manager to see which feature you can use on your telephone.

To use the listen-only speaker to place a call without lifting the handset or for any listening-only feature (such as monitoring a call on which you have been put on hold or for group listening)

1. Press **Spkr**.
2. Place a call or access the selected feature.
3. Adjust speaker volume if necessary:
To raise the volume, press the right half of the Speaker Volume control button labeled ; to lower the volume, press the left half of the Speaker Volume control button labeled .

If you have a display, it shows the volume level: (There are eight volume levels.)

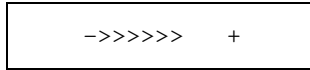

To turn off the speaker and return to handset

1. Pick up the handset.

To end a call (while the handset is on-hook and only the speaker is active)

1. Press **Spkr**.

To activate the speaker while using the handset so that both are active at the same time (the Group Listen feature, if administered)

1. While you are using the handset, activate the speaker by pressing **Spkr**.

Note: If you hang up the handset within 10 seconds after pressing **Spkr**, the call remains active on the speaker.

If you hang up the handset more than 10 seconds after pressing **Spkr**, the speaker will also turn off, and the call is disconnected.

Speakerphone

The two-way built-in speakerphone allows you to place and answer calls without lifting your handset.



Note: Your telephone may be set for the two-way *speakerphone* or for the one-way, listen-only *speaker*. Check with your system manager to see which of these features you can use.

Note: Speakerphones may not operate satisfactorily in every environment (such as in very noisy locations). In such an environment, the one-way, listen only speaker should be used.

Note: Some locations may wish to use the speakerphone for the Group Listen feature. With this feature you can hear the other person through the handset and speakerphone, but in order to speak to the other person, you must use the handset. Ask your system manager if the Group Listen feature has been administered for your telephone.

To place or answer a call without lifting the handset, or to use the speakerphone with any feature

1. Press **Spkr**.
2. Place or answer the call, or access the selected feature.
3. Adjust speakerphone volume if necessary:

To raise the volume, press the right half of the Volume control button labeled ; to lower the volume, press the left half of the Volume control button labeled .

4. If you have a display, it shows the volume level:
(There are eight volume levels.)

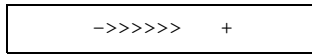

To change from the speakerphone to the handset

1. Pick up the handset and talk.

To change from the handset to the speakerphone

1. Press **Spkr**.
2. Within 10 seconds, hang up the handset.

To use the Group Listen feature (if administered) in which the handset and the speaker are active at the same time

1. While you are active on the handset, press **Spkr**.

Note: If you hang up the handset within 10 seconds after pressing **Spkr**, the call remains active on the speaker.

If you hang up the handset more than 10 seconds after pressing **Spkr**, the speaker will also turn off, and the call is disconnected.

To end a call

1. Press **Spkr** again.

Test

The Test feature allows you to test the lights and display on your telephone.

To test the lights and display on your telephone

1. While on-hook, press and hold down **Trnsfr**.

Lights go on in columns, and if there is a display on the telephone, all the display segments fill in.

2. To end test, release **Trnsfr**.

Lights return to normal operation.

Note: If the lights or the display segments do not respond during the test, see your system manager.

Transfer

The Transfer feature allows you to transfer a call from your telephone to another extension or outside number.

To send the present call to another extension

1. While on a call, press **Trnsfr**. [*dial tone*]
2. Dial the number to which the call is to be transferred. [*ringing tone*]
3. Remain on the line and announce the call.
(If the line is busy or if there is no answer, you can return to the held call by pressing its call appearance button.)

4. Press **Trnsfr** again to complete the transfer.
5. Hang up.

Note: If your telephone is connected to a DEFINITY Release 6.3.2 or a later release, your administrator may have chosen Transfer-on-Hang-up. In this case, you can transfer a call by pressing **Trnsfr**, dialing the number to which the call is to be transferred, and then hanging up. To cancel an attempted transfer, press **Drop** or press the original call appearance. If your system has auto-hold activated, use **Drop** to cancel a transfer so that the potential transfer recipient is not left on hold.

Getting Messages

Message

Your Message light goes on when a caller has left a message for you.

Note: If your telephone has a display, you may also be able to use the Message Retrieval display feature.

For directions on retrieving your messages, see your system manager.

Selecting a Personalized Ring

Select Ring

The Select Ring feature allows you to choose your own personalized ringing pattern for your telephone from among eight different patterns.

To select a personalized ringing pattern

1. While on-hook, press **Conf**.

Current ringing pattern plays and repeats every three seconds.

2. Continue to press (and then release) **Conf** to cycle through all eight ringing patterns.
3. If you want to save the ringing pattern currently being played, do not press **Conf** anymore. You will hear the selected ringing pattern two more times, and then it will be automatically saved.

You will hear a confirmation tone (two rising tones), and your new ringing pattern is set.

Note: If you go off-hook, receive a call, or lose power during selection, the process is canceled and you must start again.

Selected Voice Features

Abbreviated Dialing/Automatic Dialing (AD)

The Abbreviated Dialing (AD) feature allows you to store selected telephone numbers for quick and easy dialing. Each number can be a complete or partial telephone number, an extension number, or a trunk or feature access code. Abbreviated Dialing offers four possible types of lists — Personal, Group, System, and Enhanced, and you can have a total of three lists. (Of these three lists, you can have only one System List and one Enhanced List.) You program numbers on a Personal List; numbers on Group Lists are programmable by the controller of the list; System Lists and Enhanced Lists are programmable only by the system manager.

You can also program a number on an AD button that is *not* stored on an AD list. This Automatic Dialing number can be up to 16 digits and characters.

For all 6408+ telephones, and all 6408D+, 6416D+ and 6416D+M, and 6424D+ and 6424D+M telephones connected to DEFINITY switches 6.2 and prior releases, or when using the Program feature access code To program/reprogram an AD button (administered as a feature button)



Note: The system manager must first program a call appearance/feature button as an AD button before you can program a number on it.

Note: There is a 10-second time limit between your entering the Program mode and entering the first digit of an AD button, and then a 10-second time limit between each digit. If you hear intercept tone while you are programming the button, you have exceeded the time limit and you must begin again.

1. Locate the Program button on your telephone. There are three possibilities.
 - a. If you are using a telephone with a display, press the **Menu** button and, if necessary, the **Next** or **Prev** button until **Prog** appears on the display screen.
 - b. If your telephone does not have a display or if Prog is not available on your display, press **Program** administered as a feature button.
 - c. Ask your system manager for the AD Program feature access code.
2. Pick up the handset or press **Spkr**. *[dial tone]*
3. Press the **Prog** button (or dial the feature access code).
4. Press the AD button to be programmed.
5. Dial an outside number, extension, or feature access code you want to store (as you would normally dial it).
6. Press **#**. *[confirmation tone]*
7. Repeat Steps 4 through 6 (within 10 seconds) to program additional buttons.
8. Hang up or press **Spkr** to end programming.

For 6408D+, 6416D+ and 6416D+M, and 6424D+ and 6424D+M telephones connected to a DEFINITY ECS Release 6.3 or later
To program an Abbreviated Dialing button on the softkey feature menu screens or on a feature button

Note: If you make a mistake while programming an AD button on your display, you CANNOT move back a space to erase it. Instead, save whatever you have entered by pressing the “#” key and then start over.

1. Locate the Program button. It will either be a button labeled  or you will see **Prog** on one of the feature menu screens.
2. To access the Program feature, press the **Menu** button, then the **Next** or **Prev** button, if necessary, until you see **Prog** on the display. Then press the softkey below **Prog**. If Prog is not on one of your feature menu screens, press the  button.

Your telephone will automatically go off-hook, and the light next to  will go on.

3. Select the feature button or the AD softkey you want to program. (To do this, press the **Menu** button again, then press **Next** or **Prev**, if necessary, until you see the AD softkey label, such as AD1, on the display.)

*You will see the message, **Change number? Yes=1 No=2** on the display.*

4. If you want to enter a new number or change an existing number, press the “1” key on the dial pad. If you do not want to change the number, press the “2” key and skip to Step 6.
5. When you see the message **Enter number:** on the display, enter the number you want that button to call. When you have finished entering the number, press the “#” key. Go on to the next step.

Note: When you have changed the number called by a feature button, you may want to change its label on the paper strip too.

6. When you see the message **Change label? Yes=1 No=2**, press the “1” key on the dial pad to change a button label. If you do not want to change the label, press the “2” key and skip to Step 8.
7. When you see the message **Enter label** on the display, use the dial pad to enter the label you want, up to five characters. (Pressing a dial pad key once enters the first letter on the key; if you want a different letter or the number, press the key repeatedly until the character you want appears on the display.) Press the “*” key to advance to the next space. When you have finished entering the label, press the “#” key.
8. When you see the message **Press button to program**, decide if you want to program another button. If so, go back to Step 3. If not, go on to the next step.

Note: When you program a label, it does not appear on the display until you hang up.

9. To exit from Programming mode, press the **Speaker** button.

To place an AD call

1. Press the selected AD button, either a feature button or the softkey below the AD feature on the feature menu screens.

To program or reprogram an outside number, extension, or feature access code into an AD personal list

1. Locate the Program button on your telephone. There are three possibilities.
 - a. If you are using a telephone with a display, press the **Menu** button and, if necessary, the **Next** or **Prev** button until **Prog** appears on the display screen.
 - b. If your telephone does not have a display or if **Prog** is not available on your display, press **Program** administered as a feature button.
 - c. Ask your system manager for the AD Program feature access code.
2. Pick up the handset or press **Spkr**. *[dial tone]*
3. Press the Program button (or dial the feature access code).
4. Dial the Personal List number (**1, 2, or 3**).
5. Dial the list item (**1, 2, 3...**).
6. Dial the number you want to store (up to 24 digits) as you would normally dial it.
7. Press **#**. *[confirmation tone]*
8. Repeat Steps 5 through 7 if you want to program additional items on the same list; hang up and begin again at Step 2 if you want to program items on another list.
9. Hang up or press **Spkr** to end programming.

Note: Record your personal list items on the Abbreviated Dialing list on the cards in the tray under the telephone; group, system, and enhanced list can be obtained from your system manager.

To place a call using an AD list button or code

1. Press the **Pers List** or **Grp List** or **Sys List** buttons (if administered) **or** Dial the appropriate AD List code for List 1, or List 2, or List 3. *[dial tone]*

Note: An **Enhcd List** (Enhanced List) may also be available; see your system manager.

2. Dial the desired list item (**1, 2, 3...**).

Call Forwarding All Calls

The Call Forwarding feature temporarily forwards all your calls to another extension or to an outside number, depending on your system.

To temporarily redirect all calls to an extension or outside number of your choice

1. **With a display:** Press the **Menu** button and then press the softkey below **CFrwd** (while on-hook or off-hook).

Without a display: Press the **Call Fwd** button (if administered) (while on-hook or off-hook) **or** Dial the Call Forward access code (while off-hook). *[dial tone]*

Note: If you have console permission, next, dial the extension number whose calls are to be forwarded; receive dial tone.

2. Dial the extension or number where calls will be sent.
[confirmation tone]
3. Hang up.

To cancel Call Forwarding

1. **With a display:** Press the **Menu** button and then press the softkey below **CFrwd** (while on-hook or off-hook).
2. **Without a display:** Press the **Call Fwd** button (while on-hook) **or** Dial the Call Forward cancel code (while off-hook). *[confirmation tone]*.

Call Park

The Call Park feature allows you to put a call on hold at your telephone, for retrieval at any extension.

To park a call at your extension (for retrieval at any extension)

Note: To use the Call Park feature on a telephone with display (if Call Park is one of your softkey features), press the **Menu** button and then the softkey below **CPark**. Then hang up.

or, if a **Call Park** button has been assigned to your telephone, press the **Call Park** button (if administered) and hang up.

Otherwise, follow these instructions to park a call at your extension.

1. Press **Trnsfr**. *[dial tone]*
2. Dial the Call Park access code. *[confirmation tone]*
3. Press **Trnsfr** again.
Call is parked at your extension.
4. Hang up.

To retrieve a parked call from another extension

1. Pick up the handset or press **Spkr**.
2. Dial the Call Park access code. *[confirmation tone]*
3. Dial the extension where the call is parked. *[confirmation tone]*
If returning to a call parked at your telephone, dial your own extension.

Call Pickup and Directed Call Pickup

The Call Pickup feature lets you answer a call at your telephone for another extension in your pickup group. If you can use the Directed Call Pickup feature, you can pick up a call ringing at a specific extension without the person's being a member of your pickup group.

To answer a call placed to a member of your pickup group when your telephone is idle

1. **With a display:** Press the **Menu** button and then press the softkey below **CPkUp**.

Without a display: Press the **CallPickup** button (if administered) **or** Dial the Call Pickup access code.

Called telephone stops ringing, and you are connected to the ringing call.

To pick up a call directly for someone else in your office

Note: Again, the Directed Call Pickup feature is designed for covering calls for someone while they are away from their desk. In this case, you do *not* have to be a member of the same pickup group.

1. Press the **DirCall PkUp** button **or** Dial the Directed Call Pickup access code.
2. Dial the extension of the ringing telephone.

Called telephone stops ringing, and you are connected to the ringing call.

Leave Word Calling

The Leave Word Calling (LWC) feature leaves a message for a person at another extension to call you back. The called party will be able to dial message service (for example, an attendant, AUDIX or other voice mail system, a covering user, etc.) to retrieve a short, standard message which gives your name and extension, the date and time you called, and the number of times you called.

To leave a message after dialing an extension (when your call is not answered, you hear a coverage or busy tone, or you have been put on hold)

1. **With a display:** Press the **Menu** button and then press the softkey below **LWC** before hanging up.

Without a display: Press the **LWC** button (if administered) before hanging up. *[confirmation tone]*

Message light goes on at the called telephone (if so equipped).

Note: If reorder tone is heard, message is not stored; try again.

To leave a message without ringing an extension

1. **With a display:** Press the **Menu** button and then press the softkey below **LWC**.

Without a display: Press the **LWC** button **or** Dial the Leave Word Calling access code (while off-hook). *[dial tone]*

2. Dial the extension. *[confirmation tone]*
Message light goes on at the called telephone (if so equipped).
3. Hang up.

To cancel a Leave Word Calling message

Note: You cannot cancel a message left for an AUDIX subscriber.

1. **With a display:** Press the **Menu** button and then press the softkey below **CnLWC** (while on-hook or off-hook).

Without a display: Press the **Cancel LWC** button (while on-hook or off-hook) **or** Dial the Leave Word Calling cancel code (while off-hook). *[dial tone]*

2. Dial the extension. *[confirmation tone]*

Note: If reorder tone is heard, the message is not canceled; try again.

Self-Administration

If your telephone has a display and the Self-Administration feature has been activated, you will be able to add (or to remove) feature buttons on your own telephone using the softkeys and the display control buttons.

To administer any of the available features

1. Press the **Menu** button and then the softkey below **Admin**.

Note: The telephone must be idle; that is, there must NOT be any active or held calls.

2. If necessary, enter your security code at the telephone dial pad.

Note: If you enter an invalid security code, *the telephone beeps and the display shows Incorrect Security Code and Cont. (for Continue)*. Press the softkey below **Cont.** to proceed.

When you have entered the security code, press the softkey below **Done**.

The display shows the first SELECT FEATURE screen which lists the first set of four self-administrable features. To see the second set of four features, press the Next button. To go back one menu screen, press the Prev button.

3. Press the softkey below the feature you want to place on an available feature button such as **CPkUp** (Call Pickup) or **SAC** (Send All Calls).

Note: If you choose the Automatic Dialing or Group Paging feature, the display prompts you to add a number such as a telephone number, extension, or trunk code that will be associated with this particular button. When you have entered the correct number, press the softkey below **Done**.

Note: If you wish to see the full name of any of the features on the feature menu screens (called LongMode), press the softkey below **Expl?**

4. Press the button on which you wish to assign this feature.

If the feature is successfully administered on the feature button, the display shows: "Button Programmed!" Go on to Step 5.

Note: If there is already a feature programmed on that button, you see the following screen:

XXXXX FEATURE ON BUTTON		
Replace	Keep	Delete

On this display screen, press either of the softkeys below **Replace** if you want to replace the current feature on that button. Press the softkey below **Keep** if you want to keep the feature on that button. Press the softkey below **Delete** if you want to delete the feature from the button and leave that button blank.

5. When you see the "BUTTON PROGRAMMED!" screen on the display, do one of the following:
 - If you want to administer another button on your telephone, press the softkey below **Cont** (Continue) on the second line of the "BUTTON PROGRAMMED" screen. The display returns to the feature list. Repeat Steps 3 and 4 to administer other buttons.
 - To end self-administration and return to Normal call-handling mode, press the **Exit** button.

Note: Be sure to write the name of the self-administered feature(s) on the telephone designation card next to the appropriate button.

Send All Calls

The Send All Calls feature temporarily sends all your calls to another extension in the same system.

Note: Before you can use this feature, your system manager must provide a coverage path for your extension.

To send all calls (except priority calls) immediately to coverage

1. **With a display:** Press the **Menu** button and then press the softkey below **SAC** (while on-hook).

Without a display: Press the **Send Calls** button (while on-hook) **or** Dial the Send All Calls access code (while off-hook) [confirmation tone]

To cancel Send All Calls

1. **With a display:** Press the **Menu** button and then press the softkey below **SAC** again (while on-hook).

Without a display: Press the **Send Calls** button again (while on-hook) **or** Dial the Send All Calls cancel code (while off-hook).
[confirmation tone]

Whisper Page

The Whisper Page feature allows you, if you have appropriate permissions, to make an announcement to a person at another extension currently on another call. Only the person at the other extension hears the announcement; the other person on the call cannot hear the message.

Note: If you are connecting the headpiece to the Handset jack on the 6400 Series telephones, the M10L-8400 is the only modular base unit that should be used. If you use any other modular base unit, the Whisper Page announcement may be overheard by the other person on the call.

To make an important announcement (such as an incoming call) to someone at another extension busy on another call

1. Press the **Whisper Page** button *or* Dial the Whisper Page access code.

Both people on the other call hear a beep.

*The person whom you have called can press the **Whisper Answer** button which forms a two-party speaking path with your telephone. The other call is put on hold and that person cannot hear your conversation.*

2. Speak with the person you have called.

Note: If the person whom you have called is not using the telephone at the time you activate Whisper Page, the call is converted to a normal call.

Note: Any person in the system with the **Whisper Answer** button administered on the telephone can block Whisper Page calls by pressing the **Whisper Off** button.

Display Features

Note: To ensure easier display visibility, the display on the 6408D+, 6416D+ and 6416D+M, and 6424D+ and 6424D+M can be left in its horizontal position or can be raised to a slightly steeper angle. Check which viewing angle is best for your workstation.

Time and Date

Ordinarily, the time and the date will appear on the upper line of your display. (The 6408+ does *not* have a display.) The time and date are set at the switch, so if there is an error, contact your system manager.

Note: On initially plugging in a 6400 Series display telephone or after a power outage, it may take approximately 15 minutes before the time and date appear on the screen.

Call Information

The 6408 telephones have eight call appearance buttons; the 6416D+ and 6416D+M have 16; the 6424D+ and 6424D+M have 24 buttons. Beginning with the first button in the upper left hand corner of your faceplate and going down, the display identifies the buttons in the left column as **a** through **h**. The

buttons in the right column begin with **i** and then go through **p** (on the 6416D+ and 6416D+M) and through **x** (on the 6424D+ and 6424D+M). When the display shows **a=** , it represents call information for the first call appearance button. The next button down would be shown as **b=** , and so on.

When you dial an extension, that number is shown and then replaced by the called party's name and extension. When a call is received from another extension, the caller's name is shown; when a call is received from outside, "OUTSIDE CALL" or a trunk identifier is shown.

The display remains in Normal (call-handling) Mode until you activate one of the other display or softkey features. After using any of these features, return to Normal Mode by pressing the **Exit** button.

Call Timer and Timer

The Call Timer and the Timer features are used to measure elapsed time on a call.

However, **the Call Timer feature** can be used ONLY if your telephone is connected to a DEFINITY ECS Release 6.3 or later. This feature, once activated, measures elapsed time *automatically* on all calls until you turn off the Call Timer feature.

The Timer feature must be turned on *for each individual call* you wish to time. At the end of the call, you must immediately turn off the feature. This feature can be used with *any* DEFINITY switch release.

Check with your system manager to see if you can use either of these features.

To use the Call Timer feature to measure elapsed time on telephone calls

1. Press the **Menu** button and then press the softkey below **CTime** **or**, if **CTime** is not available on your display, press the **Call Timer** button (if administered).

The Call Timer will measure elapsed time automatically on all calls until you turn off the Call Timer feature.

2. When you want to turn off the Call Timer feature, press the **Menu** button and press the softkey below **CTime** **or**, if you have activated this feature with **Call Timer** , press the **Call Timer** button.

To use the Timer feature to measure elapsed time on an individual telephone call

1. Press the **Menu** button and then press the softkey below **Timer** (which exits you from softkey mode) **or**, if **Timer** is not available on your display, press the **Timer** button (if administered).
2. To stop the timer and clear the display, press the **Menu** button and then press the softkey below **Timer** again **or**, if **Timer** is not available on your display, press **Timer** again.

Directory

The Directory feature allows you to search for the extension of another user in your location by keying in the user's name at the dial pad.

To search the directory for a name

1. Press the **Menu** button and then press the softkey below **Dir or**, if **Dir** is not available on your display, press the **Directory** button (if administered).
2. Key in the selected name with dial pad keys: **last name, comma** (use *****), **first name or initial**.
3. Press the **Next** button for each successive directory name you wish to see.
4. To search for a new name, press the softkey below **Dir** or press the **Directory** button and go through the above sequence again.
5. When you are ready to exit the directory, press the **Exit** button.

To place a call to the name shown on the display

1. Pick up the handset.
2. While the name is shown, press the **Call Disp** button (if administered) **or**, if you do not have a **Call Disp** button on your set, press the **Exit** button and then dial the number using the dial pad.

Note: You can also leave your handset on-hook. The speakerphone will turn on automatically when you press **Call Disp**.

Exit

Use the Exit feature to leave Display Mode (after using any display or softkey feature) and return to Normal Mode. You can then use the display to view the time and date and to identify call appearance, calling/called party, and calling/called number.

To exit a display feature and return to Normal (display) Mode

1. Press the **Exit** button.

Display will show the time and date or, when applicable, call/caller information.

Inspect

The Inspect feature shows you call-related information for an incoming call when you are already active on a call, or, with this feature, you can see who is on hold.

To use the Inspect feature

1. Press the **Menu** button and then press the softkey below **Inspt or**, if **Inspt** is not available on your display, press the **Inspect** button (if administered).

2. Press the call appearance button in question.

*Information is shown on the display screen;
you remain connected to the present call.*

3. To return to the held call, press the **Exit** button and then the call appearance button of the held call.

Stored Number/View

The Stored Number or View feature allows you to check: 1) the number stored as an item on an Abbreviated Dialing list, 2) the number you last dialed (via Last Number Dialed feature), or 3) the name of the feature that has been programmed on any of your telephone's call appearance/feature buttons.

To view the number stored as a list item

1. Press the **Menu** button and then press the softkey below **BtnVu**
or Press the **View** button.
2. Press the selected **Pers List** or **Grp List** or **Sys List** button
or Dial the appropriate AD List code for List 1, or List 2, or List 3.

Note: An **Enhcd List** (Enhanced List) may also be available; see your system manager.

3. Dial the selected list item (**1, 2, 3...**).

Stored number is shown.

4. Hang up.
5. To return to the Normal (display) Mode, press the **Exit** button or begin again at Step 2 to see another stored number.

To view the feature stored on a call appearance/feature button OR the last number you dialed OR a number stored on an AD button

1. Press the **Menu** button and then press the softkey below **View**
or, if **View** is not available on your display, press the **View** button.
2. Press the selected feature button.

Note: To view the last number you dialed, press **Redial**, or to view the number stored on an AD button, press the selected AD button.

3. To return to the Normal (call-handling) Mode display, press the **Exit** button or repeat Step 2 to see another stored number.

Modular Interface Capabilities

If you are using a 6416D+M or 6424D+M telephone, you can install a module in the telephone's desktop stand for increased set functionality. [Figure 5](#) shows the rear of the desktop stand on these telephones. Number **1** in [Figure 5](#) shows the module opening on the back of the stand. Remove the cover (shown as **2**) before you install the module. For more information about specific modules, see the documentation supplied with the module.

Note: These modules can ONLY be used in the desktop position; they CANNOT be used if the telephone is to be wall-mounted.

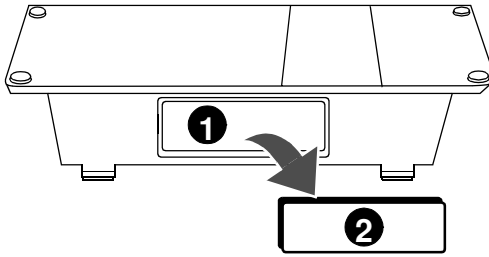

FIGURE 5 A Rear View of the 6416D+M and 6424D+M Telephones

Telephone Installation

All of the 6400 Series telephones described in this manual can be either desk-mounted or wall-mounted. Use the following directions for installing any of these telephones. [Figure 6](#) shows the back of the 6400 Series telephones.

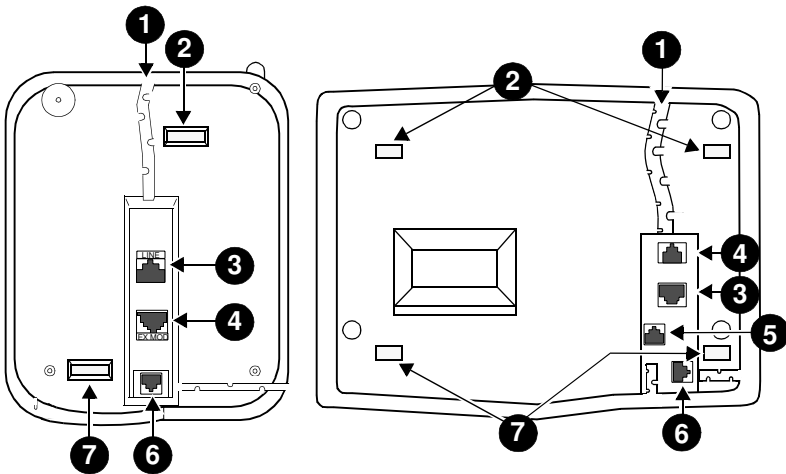



FIGURE 6 The Bottom of the 6400 Series Telephones

Desktop Installation

Note: In non-modular 6400 Series telephones, you can use the telephone without the desktop stand, if you so choose. *(If the telephone desktop stand contains the modular interface, the desktop stand must be left connected to the telephone.)*

If you do not use the telephone with attached desktop stand, it is suggested that you place small round feet (included in a plastic bag in

the box in which the telephone was packed) on each corner of the bottom of the telephone housing.

1. Turn the telephone face down on a flat surface.
2. Remove the desktop stand (the upper tabs on the stand are shown as **2** in [Figure 6](#); the lower tabs are shown as **7** in [Figure 6](#)). If you are using a 6416D+M or 6424D+M telephone and want to install the adjunct module, do so now before proceeding with the following steps. For more information on the installation of the module, see the documentation that came in the box with the module.
3. Snap one end of the line cord (D2R or D8W) into the “LINE” jack (**3** in [Figure 6](#)) on the bottom of the telephone.
4. If you are installing a 6416D+ or 6416D+M or a 6424D+ or 6424D+M with a connected expansion module, snap one end of the expansion module cord into the “XM24” jack (**4** in [Figure 6](#)).
5. Thread the line cord (and expansion module cord, if appropriate) through the routing channel leading to the top of the desktop stand (**1** in [Figure 6](#)). Make sure that each cord is placed securely under the square tabs in the routing channel.
6. Snap one end of the coiled handset cord into the Handset jack (**6** in [Figure 6](#)). This jack is labeled . Thread the handset cord into the channel leading to the side edge of the telephone).
7. Turn the telephone right side up, with the front facing you.
8. Snap the free end of the handset cord into the handset and place the handset in the cradle.
9. If appropriate, snap the free end of the expansion module cord into the TEL SET jack on the expansion module.
10. Snap the free end of the line cord into the modular wall jack.
11. Lift the handset and listen for dial tone. If there is no dial tone, check all wire connections to make sure they are secure.

Note: If you are using a headset with the telephone, you can connect it to the Handset jack (**6** in [Figure 6](#)) or the Headset jack on some telephones (**5** in [Figure 6](#)).

Wall Installation

Note: For wall-mounting, you will need a 1-foot line cord. (This cord is *not* supplied with the telephone, but can be ordered by using this comcode: 103786760.)

If you are wall-mounting the telephone, you should remove the tray from the base of the telephone. For this purpose, use the instructions listed under “Removing the Telephone Tray” later in this guide.

1. Make sure the 8-conductor wall mount plate is in place.
2. Do the following to reverse the handset hook. (**a** in [Figure 7](#) shows the handset retainer located under the handset.)

- In order to release the handset retainer hook, press down on the hook and slide it toward the top of the telephone. (See **b** in [Figure 7](#).)
- Rotate the hook 180 degrees (as in **c** in [Figure 7](#)) and then slide it back into its slot so the bottom part now sticks out from the top. (See **d** in [Figure 7](#).) Snap the hook firmly into place.

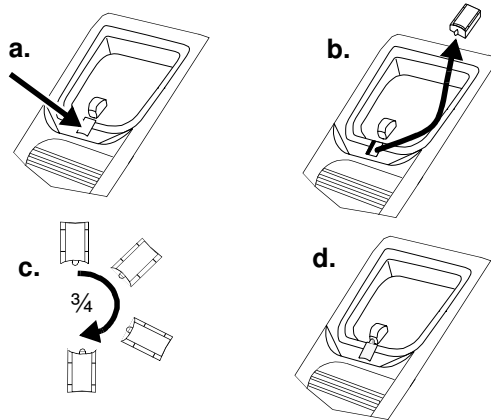

FIGURE 7 Removing, Rotating, and Replacing the Handset Retainer

3. Place the telephone face down on a flat surface.
4. Remove the desktop stand which is attached to the base of the telephone by tabs on the top and back of the stand, shown as **2** and **7** in [Figure 6](#) on [page 25](#).

Note: [Figure 8](#) below shows the removal of the desktop stand from two different 6400 Series telephone models. Check to see which model is most like the back of your telephone.

- Press inward on the top of the stand until you can lift the upper tab(s) of the stand (shown as **1** in the figure below) out of the tab slot(s) (shown as **2** in the figure below) on the telephone.
- Lift the bottom of the stand out of the lower tab slot(s).

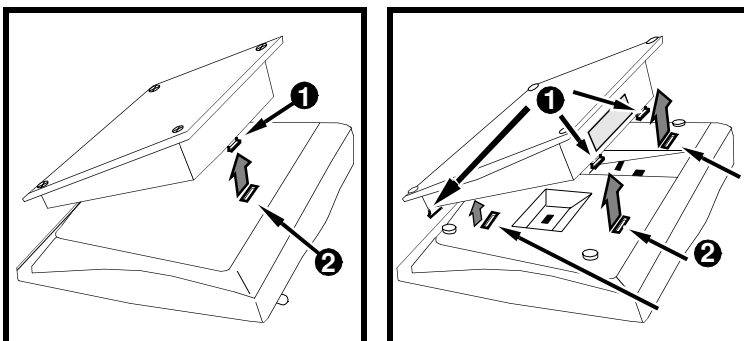



FIGURE 8 Removing the Desktop Stand

5. Reverse the desktop stand so that the larger end is facing down.
6. Snap the line cord into the "LINE" jack in the bottom of the telephone and coil the excess cord in the back of the deskstand.
7. Snap one end of the coiled handset cord into the Handset jack (labeled ). Thread the handset cord into the channel leading to the side edge of the telephone
8. Slowly lower the reversed deskstand onto the bottom of the telephone until the tabs at the top and bottom of the deskstand snap into the appropriate slots on the bottom of the telephone.
9. Place the free end of the line cord through the opening in the middle of the deskstand and then snap the free end of the line cord into the wall jack.
10. Place the base of the telephone on the wall-jack mounting studs, and pull downward until it is secure. (See [Figure 9](#).)

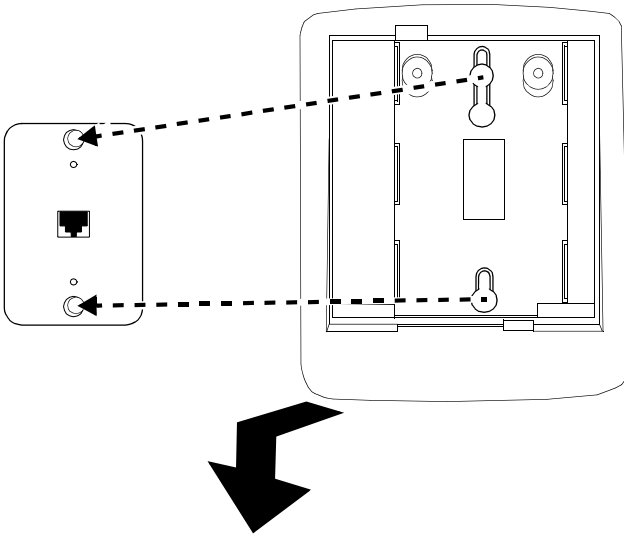

FIGURE 9 Placing the Telephone on the Wall Jack Mounting Studs

11. Snap the free end of the handset cord into the handset and place the handset in the cradle.

Note: The handset hook you repositioned will hold the handset in place.

12. Lift the handset and listen for dial tone. If there is no dial tone, check all wire connections to make sure they are secure.

Removing the Telephone Tray

You may wish to remove the tray from the base of the telephone, especially if you are wall-mounting the telephone. See [Figure 10](#) for further help.

1. Pull the tray from the base of the telephone as far as it will go.
2. Using your thumb, press down on the center of the tray.
3. Continue to pull the tray until it is completely separated from the base.

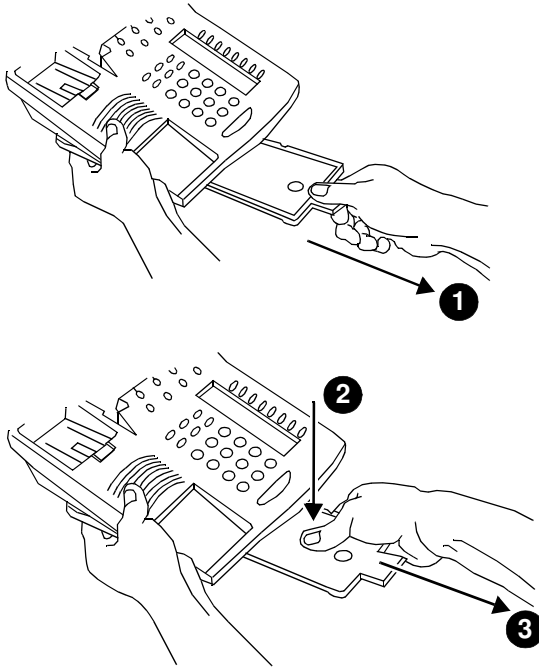

FIGURE 10 Removing the Tray from the Base of the Telephone

Installing the Designation Card

Use the button designation card to write the telephone number, extension, name, or feature that each call appearance/feature button can access. In order to help you match the designation cards with the call appearance/feature buttons on the telephone, the columns of button labels are marked with the 6400 Series multi-line telephone model with which the label can be used.

Below the perforated bottom edge of each designation card is a telephone number card on which you can write your telephone number or extension.

To label and install the designation card and telephone number card

1. Print the numbers/features on the button designation card that corresponds with the telephone you are using, and type or write your phone number or extension on the telephone number card (labeled **Tel no.**).
2. Crease the perforated edges of the cards you have filled out and then tear the button designation strips and the station number card along the perforations.
3. Place the button designation card and telephone number card under the plastic card cover on the telephone by doing the following:
 - The transparent designation card cover is attached to the frame of the telephone by tabs on the top and bottom of the cover. Remove the cover by pulling the top tab forward and then lifting the bottom of the transparent cover from the telephone.
 - Place the designation card(s) on the telephone and then replace the transparent cover over the card by inserting the tabs at the bottom and then pressing the top down until it clicks.

Note: You can order additional designation cards in quantities of 25 cards and 100 cards per package. Use the following comcodes when you place your order.





25 sheets of designation and telephone number cards:
Comcode: CC847984614

100 sheets of designation and telephone number cards:
Comcode: CC847984622



Tones and Their Meaning

Note: The tables below describe the defaults for each ringing and feedback tone. Check with your system manager to verify if the descriptions in the **Meaning** column are accurate for your system.







Ringing Tones are produced by an incoming call.

Ringing Tones		
Rings		Meaning
	1 ring	A call from another extension.
	2 rings	A call from outside or from the attendant
	3 rings	A priority call from another extension, or from an Automatic Callback call you placed.
	ring-ping (half-ring)	A call redirected from your telephone to another because Send All Calls or Call Forwarding All Calls is active.



Feedback tones are those which you hear through the handset (receiver) or the speaker.

Feedback Tones		
Tones		Meaning
	busy	A low-pitched tone repeated 60 times a minute; indicates the number dialed is in use.
	call waiting ringback	A ringback tone with lower-pitched signal at the end; indicates the extension call is busy, and the called party has been given a call waiting tone. If you hear this tone, you may wish to activate Automatic Callback
	confirmation	Three short bursts of tone; indicates a feature activation or cancellation has been accepted.

continued on next page

Feedback Tones (continued)		
Tones		Meaning
	coverage	One short burst of tone; indicates your call will be sent to another extension to be answered by a covering user.
	dial	A continuous tone; indicates dialing can begin.
	intercept/ time-out	An alternating high and low tone; indicates a dialing error, a denial of the service requested, or a failure to dial within a preset interval (usually 10 seconds) after listing the handset or dialing the previous digit.
	recall dial	Three short bursts of tone followed by a steady dial tone; indicates the feature request has been accepted and dialing can begin.
	reorder	A fast busy tone repeated 120 times a minute; indicates all trunks are busy.
	ringback	A low-pitched tone repeated 15 times a minute; indicates the number dialed is being rung.

Line and Feature Button Lights

Line and Feature Button Lights		
Light		Meaning
	Steady red	The line you are using or will use when you lift the handset or press the Speaker button.
	Steady green	The line is in use, or the feature programmed on this button is on.
	Blinking green	You have put a call on hold on this line button.

